



## SUNNY TRIPower CORE2

## Legal Provisions

The information contained in these documents is the property of SMA Solar Technology AG. No part of this document may be reproduced, stored in a retrieval system, or transmitted, in any form or by any means, be it electronic, mechanical, photographic, magnetic or otherwise, without the prior written permission of SMA Solar Technology AG. Internal reproduction used solely for the purpose of product evaluation or other proper use is allowed and does not require prior approval.

SMA Solar Technology AG makes no representations or warranties, express or implied, with respect to this documentation or any of the equipment and/or software it may describe, including (with no limitation) any implied warranties of utility, merchantability, or fitness for any particular purpose. All such representations or warranties are expressly disclaimed. Neither SMA Solar Technology AG nor its distributors or dealers shall be liable for any indirect, incidental, or consequential damages under any circumstances.

The exclusion of implied warranties may not apply in all cases under some statutes, and thus the above exclusion may not apply.

Specifications are subject to change without notice. Every attempt has been made to make this document complete, accurate and up-to-date. Readers are cautioned, however, that product improvements and field usage experience may cause SMA Solar Technology AG to make changes to these specifications without advance notice or per contract provisions. SMA Solar Technology AG shall not be responsible for any damages, including indirect, incidental or consequential damages, caused by reliance on the material presented, including, but not limited to, omissions, typographical errors, arithmetical errors or listing errors in the content material.

### SMA Warranty

You can download the current warranty conditions from the Internet at [www.SMA-Solar.com](http://www.SMA-Solar.com).

### Software licenses

The licenses for the installed software modules (open source) can be found in the user interface of the product.

### Trademarks

All trademarks are recognized, even if not explicitly identified as such. Missing designations do not mean that a product or brand is not a registered trademark.

### SMA Solar Technology AG

Sonnenallee 1

34266 Niestetal

Germany

Phone +49 561 9522-0

Fax +49 561 9522 100

[www.SMA.de](http://www.SMA.de)

E-mail: [info@SMA.de](mailto:info@SMA.de)

Status: 4/4/2022

Copyright © 2022 SMA Solar Technology AG. All rights reserved.

# Table of Contents

<b>1</b>	<b>Information on this Document .....</b>	<b>6</b>
1.1	Validity .....	6
1.2	Target Group .....	6
1.3	Content and Structure of this Document .....	6
1.4	Levels of warning messages .....	6
1.5	Symbols in the Document .....	7
1.6	Typographical Elements in the Document .....	7
1.7	Designations in the Document .....	7
1.8	Additional Information .....	7
<b>2</b>	<b>Safety .....</b>	<b>9</b>
2.1	Intended Use .....	9
2.2	IMPORTANT SAFETY INSTRUCTIONS.....	10
<b>3</b>	<b>Scope of Delivery .....</b>	<b>15</b>
<b>4</b>	<b>Additionally Required Materials and Equipment.....</b>	<b>16</b>
<b>5</b>	<b>Product Overview .....</b>	<b>18</b>
5.1	Product Description .....	18
5.2	Symbols on the Product .....	18
5.3	Interfaces and Functions .....	20
5.4	LED Signals.....	21
5.5	System Overview .....	22
<b>6</b>	<b>Mounting.....</b>	<b>23</b>
6.1	Installing Optional AC Sealing Plate .....	23
6.2	Requirements for Mounting .....	23
6.3	Mounting to Profile Rails.....	24
6.3.1	Requirements for mounting to profile rails.....	24
6.3.2	Mounting the Product to Profile Rails .....	25
6.4	Mounting the Product on a Wall.....	28
<b>7</b>	<b>Opening the Cable Compartment .....</b>	<b>31</b>
<b>8</b>	<b>Electrical Connection .....</b>	<b>32</b>
8.1	Overview of the Connection Area .....	32
8.1.1	View from Below.....	32
8.1.2	Interior View .....	32
8.2	AC Connection.....	33

8.2.1	Requirements for the AC Connection .....	33
8.2.2	Connecting the Inverter to the Utility Grid .....	34
8.2.3	Connecting the Grounding .....	37
8.3	Connecting the Network Cables.....	38
8.4	DC Connection.....	40
8.4.1	Assembling the DC Connectors .....	40
8.4.2	Connecting the PV Array.....	42
8.4.3	Disassembling the DC Connectors .....	45
<b>9</b>	<b>Commissioning .....</b>	<b>47</b>
9.1	Commissioning Procedure .....	47
9.2	Commissioning the Inverter.....	47
<b>10</b>	<b>Operation .....</b>	<b>49</b>
10.1	Establishing a connection to the user interface .....	49
10.1.1	Establishing a Direct Connection via Ethernet .....	49
10.1.2	Establishing a Connection via Ethernet in the local network .....	49
10.2	Logging In and Out of the User Interface.....	50
10.3	Start Page Design of the User Interface.....	51
10.4	Changing the Password.....	52
10.5	Changing Operating Parameters.....	52
10.6	Configuring the Country Data Set.....	53
10.7	Configuring the Modbus Function.....	53
<b>11</b>	<b>Disconnecting the Inverter from Voltage Sources .....</b>	<b>55</b>
<b>12</b>	<b>Event messages .....</b>	<b>58</b>
<b>13</b>	<b>Decommissioning the Inverter.....</b>	<b>70</b>
<b>14</b>	<b>Procedure for Receiving a Replacement Device.....</b>	<b>73</b>
<b>15</b>	<b>Maintenance .....</b>	<b>74</b>
15.1	Safety during Maintenance.....	74
15.2	Maintenance routines .....	74
15.3	Clean the product .....	75
15.4	Maintaining the Fan.....	75
15.4.1	Removing the Fan Assembly .....	75
15.4.2	Installing the Fan Assembly.....	76
<b>16</b>	<b>Technical Data .....</b>	<b>77</b>
<b>17</b>	<b>Contact .....</b>	<b>81</b>

<b>18 EU Declaration of Conformity .....</b>	<b>82</b>
<b>19 UK Declaration of Conformity.....</b>	<b>83</b>

# 1 Information on this Document

## 1.1 Validity

This document is valid for:

- STP 110-60 (Sunny Tripower CORE2)

## 1.2 Target Group

This document is intended for qualified persons and end users. Only qualified persons are allowed to perform the activities marked in this document with a warning symbol and the caption "Qualified person". Tasks that do not require any particular qualification are not marked and can also be performed by end users. Qualified persons must have the following skills:

- Knowledge of how an inverter works and is operated
- Training in how to deal with the dangers and risks associated with installing, repairing and using electrical devices and installations
- Training in the installation and commissioning of electrical devices and installations
- Knowledge of all applicable laws, standards and directives
- Knowledge of and compliance with this document and all safety information

## 1.3 Content and Structure of this Document

This document describes the mounting, installation, commissioning, configuration, operation, troubleshooting and decommissioning of the product as well as the operation of the product user interface.

You will find the latest version of this document and further information on the product in PDF format and as eManual at [www.SMA-Solar.com](http://www.SMA-Solar.com).







Illustrations in this document are reduced to the essential information and may deviate from the real product.

## 1.4 Levels of warning messages

The following levels of warning messages may occur when handling the product.

 <b>DANGER</b>
Indicates a hazardous situation which, if not avoided, will result in death or serious injury.
 <b>WARNING</b>
Indicates a hazardous situation which, if not avoided, could result in death or serious injury.
 <b>CAUTION</b>
Indicates a hazardous situation which, if not avoided, could result in minor or moderate injury.
<b>NOTICE</b>
Indicates a situation which, if not avoided, can result in property damage.

## 1.5 Symbols in the Document

Icon	Explanation
	Information that is important for a specific topic or goal, but is not safety-relevant
	Indicates a requirement for meeting a specific goal
	Desired result
	A problem that might occur.
	Example
	Sections describing activities to be performed by qualified persons only

## 1.6 Typographical Elements in the Document

Typographical element	Use	Example
<b>bold</b>	<ul style="list-style-type: none"> <li>Messages</li> <li>Terminals</li> <li>Elements on a user interface</li> <li>Elements to be selected</li> <li>Elements to be entered</li> </ul>	<ul style="list-style-type: none"> <li>Connect the insulated conductors to the terminals <b>X703:1</b> to <b>X703:6</b>.</li> <li>Enter <b>10</b> in the field <b>Minutes</b>.</li> </ul>
>	<ul style="list-style-type: none"> <li>Connects several elements to be selected</li> </ul>	<ul style="list-style-type: none"> <li>Go to <b>Settings &gt; Date</b>.</li> </ul>
[Button] [Key]	<ul style="list-style-type: none"> <li>Button or key to be clicked on or pressed down</li> </ul>	<ul style="list-style-type: none"> <li>Select <b>[Enter]</b>.</li> </ul>
#	<ul style="list-style-type: none"> <li>Placeholder for variable components (e.g., parameter names)</li> </ul>	<ul style="list-style-type: none"> <li>Parameter <b>WCtHz.Hz#</b></li> </ul>

## 1.7 Designations in the Document

Complete designation	Designation in this document
Sunny Tripower CORE2	Inverter, product

## 1.8 Additional Information

For more information, please go to [www.SMA-Solar.com](http://www.SMA-Solar.com).

Title and information content	Type of information
"PUBLIC CYBER SECURITY - Guidelines for a Secure PV System Communication"	Technical Information
"Efficiency and Derating" Efficiency and derating behavior of the SMA inverters	Technical Information
"Parameters and Measured Values" Overview of all inverter operating parameters and their configuration options	Technical Information
"SMA and SunSpec Modbus® Interface" Information on the Modbus interface	Technical Information
"Modbus® parameters and measured values" Device-specific list of the Modbus register	Technical Information
"Temperature Derating"	Technical Information



## 2 Safety

### 2.1 Intended Use

The Sunny Tripower is a transformerless PV inverter, with 12 MPP trackers, that converts the direct current of the PV array to grid-compliant, three-phase current and feeds it into the utility grid.

The product is intended for use in industrial environments.

The product must only be accessible to qualified persons.

The product complies with EN 55011 of class A, group 1:

- a.c. mains power port:  $\leq 20$  kVA
- d.c. power port:  $> 75$  kVA
- Electromagnetic radiation disturbance:  $\leq 20$  kVA

In accordance with EN 55011, the product must only be operated at locations where the distance between the product and third-party radio-communication installations is greater than 30 m. This distance must be maintained from persons carrying radio or electromagnetically sensitive equipment.

The product is not intended to be used in living areas and cannot provide protection of radio reception against interference signals in such environments.

The product is suitable for indoor and outdoor use.

The product must only be operated with PV modules of protection class II in accordance with IEC 61730, application class A. The PV modules must be compatible with this product.

The product is not equipped with an integrated transformer and therefore has no galvanic isolation. The product must not be operated with PV modules whose outputs are grounded. This can cause the product to be destroyed. The product may be operated with PV modules whose frame is grounded.

All components must remain within their permitted operating ranges and their installation requirements at all times.

The product must only be used in countries for which it is approved or released by SMA Solar Technology AG and the grid operator.

Use SMA products only in accordance with the information provided in the enclosed documentation and with the locally applicable laws, regulations, standards and directives. Any other application may cause personal injury or property damage.

Alterations to SMA products, e.g., changes or modifications, are only permitted with the express written permission of and according to the instructions from SMA Solar Technology AG. Unauthorized alterations can be dangerous and lead to personal injury. In addition, an unauthorized alteration will void guarantee and warranty claims and in most cases terminate the operating license. SMA Solar Technology AG shall not be held liable for any damage caused by such changes.

Any use of the product other than that described in the Intended Use section does not qualify as appropriate.

The enclosed documentation is an integral part of this product. Keep the documentation in a convenient, dry place for future reference and observe all instructions contained therein.

This document does not replace any regional, state, provincial, federal or national laws, regulations or standards that apply to the installation, electrical safety and use of the product. SMA Solar Technology AG assumes no responsibility for the compliance or non-compliance with such laws or codes in connection with the installation of the product.

The type label must remain permanently attached to the product.

## 2.2 IMPORTANT SAFETY INSTRUCTIONS

Keep the manual for future reference.

This section contains safety information that must be observed at all times when working.

The product has been designed and tested in accordance with international safety requirements. As with all electrical or electronic devices, there are residual risks despite careful construction. To prevent personal injury and property damage and to ensure long-term operation of the product, read this section carefully and observe all safety information at all times.

### DANGER

#### **Danger to life due to electric shock when live components or cables are touched**

High voltages are present in the conductive components or cables of the product. Touching live parts and cables results in death or lethal injuries due to electric shock.

- Do not touch non-insulated parts or cables.
- Disconnect the product from voltage sources and ensure it cannot be reconnected before working on the device.
- Wear suitable personal protective equipment for all work on the product.

### DANGER

#### **Danger to life due to electric shock when live components or DC cables are touched**

When exposed to light, the PV modules generate high DC voltage which is present in the DC cables. Touching live DC cables results in death or lethal injuries due to electric shock.

- Do not touch non-insulated parts or cables.
- Disconnect the product from voltage sources and ensure it cannot be reconnected before working on the device.
- Do not disconnect the DC connectors under load.
- Wear suitable personal protective equipment for all work on the product.

** DANGER****Danger to life due to electric shock when live components are touched on opening the product**

High voltages are present in the live parts and cables inside the product during operation. Touching live parts and cables results in death or lethal injuries due to electric shock.

- Do not open the product during operation.
- Disconnect the product from voltage sources and ensure it cannot be reconnected before working on the device.
- Ensure that no voltage is present and wait 5 minutes before touching any parts of the PV system or the product.

** DANGER****Danger to life due to electric shock when touching live system components in case of a ground fault**

If a ground fault occurs, parts of the system may still be live. Touching live parts and cables results in death or lethal injuries due to electric shock.

- Disconnect the product from voltage sources and ensure it cannot be reconnected before working on the device.
- Only touch the cables of the PV modules on their insulation.
- Do not touch any parts of the substructure or frame of the PV array.
- Do not connect PV strings with ground faults to the inverter.
- Ensure that no voltage is present and wait 5 minutes before touching any parts of the PV system or the product.

** DANGER****Danger to life due to electric shock in case of overvoltages and if surge protection is missing**

Overvoltages (e. g. in the event of a flash of lightning) can be further conducted into the building and to other connected devices in the same network via the network cables or other data cables if there is no surge protection. Touching live parts and cables results in death or lethal injuries due to electric shock.

- Ensure that all devices in the same network are integrated in the existing overvoltage protection.
- When laying the network cable outdoors, ensure that there is suitable surge protection at the network cable transition from the product outdoors to the network inside the building.

**⚠ WARNING****Danger to life due to fire and explosion**

In rare cases, an explosive gas mixture can be generated inside the product under fault conditions. In this state, switching operations can cause a fire inside the product or explosion.

Death or lethal injuries due to hot or flying debris can result.

- In the event of a fault, do not perform any direct actions on the product.
- Ensure that unauthorized persons have no access to the product.
- Do not operate the DC load-break switch on the inverter in case of an error.
- Disconnect the PV array from the inverter via an external disconnection device. If there is no disconnecting device present, wait until no more DC power is applied to the inverter.
- Disconnect the AC circuit breaker, or keep it disconnected in case it has already tripped, and secure it against reconnection.
- Only perform work on the product (e.g., troubleshooting, repair work) when wearing personal protective equipment for handling of hazardous substances (e.g., safety gloves, eye and face protection, respiratory protection).

**⚠ WARNING****Risk of injury due to toxic substances, gases and dusts.**

In rare cases, damages to electronic components can result in the formation of toxic substances, gases or dusts inside the product. Touching toxic substances and inhaling toxic gases and dusts can cause skin irritation, burns or poisoning, trouble breathing and nausea.

- Only perform work on the product (e.g., troubleshooting, repair work) when wearing personal protective equipment for handling of hazardous substances (e.g., safety gloves, eye and face protection, respiratory protection).
- Ensure that unauthorized persons have no access to the product.

**⚠ WARNING****Danger to life due to electric shock from destruction of the measuring device due to overvoltage**

Overvoltage can damage a measuring device and result in voltage being present in the enclosure of the measuring device. Touching the live enclosure of the measuring device results in death or lethal injuries due to electric shock.

- Only use measuring devices with a DC input voltage range of 1100 V or higher.

**⚠ CAUTION****Risk of burns due to hot enclosure parts**

The enclosure and the enclosure lid may get hot during operation. The DC load-break switch can not become hot.

- Do not touch hot surfaces.
- Wait until the inverter has cooled down before touching the enclosure or enclosure lid.

### CAUTION

#### **Risk of injury due to weight of product**

Injuries may result if the product is lifted incorrectly or dropped while being transported or mounted.

- Transport and lift the product carefully. Take the weight of the product into account.
- Wear suitable personal protective equipment for all work on the product.
- Transport the product using the carrying handles or hoist. Take the weight of the product into account.
- Use all carrying handles provided during transport with carrying handles.
- Do not use the carrying handles as attachment points for hoist equipment (e.g. straps, ropes, chains). Insert eye bolts into threads provided on top of the product to attach the hoist system.

### NOTICE

#### **Damage to the enclosure seal in subfreezing conditions**

If you open the product when temperatures are below freezing, the enclosure seals can be damaged. Moisture can penetrate the product and damage it.

- Only open the product if the ambient temperature is not below  $-5^{\circ}\text{C}$ .
- If a layer of ice has formed on the enclosure seal when temperatures are below freezing, remove it prior to opening the product (e.g. by melting the ice with warm air).

### NOTICE

#### **Damage to the product due to sand, dust and moisture ingress**

Sand, dust and moisture penetration can damage the product and impair its functionality.

- Only open the product if the humidity is within the thresholds and the environment is free of sand and dust.
- Do not open the product during a dust storm or precipitation.
- Close tightly all enclosure openings.

### NOTICE

#### **Damage to the inverter due to electrostatic discharge**

Touching electronic components can cause damage to or destroy the inverter through electrostatic discharge.

- Ground yourself before touching any component.

### NOTICE

#### **Damage to the product due to cleaning agents**

The use of cleaning agents may cause damage to the product and its components.

- Clean the product and all its components only with a cloth moistened with clear water.

** The country data set must be set correctly.**

If you select a country data set which is not valid for your country and purpose, it can cause a disturbance in the PV system and lead to problems with the grid operator. When selecting the country data set, you must always observe the locally applicable standards and directives as well as the properties of the PV system (e.g. PV system size, grid-connection point).

- If you are not sure which standards and directives are valid for your country or purpose, contact the grid operator.

### 3 Scope of Delivery

Check the scope of delivery for completeness and any externally visible damage. Contact your distributor if the scope of delivery is incomplete or damaged.

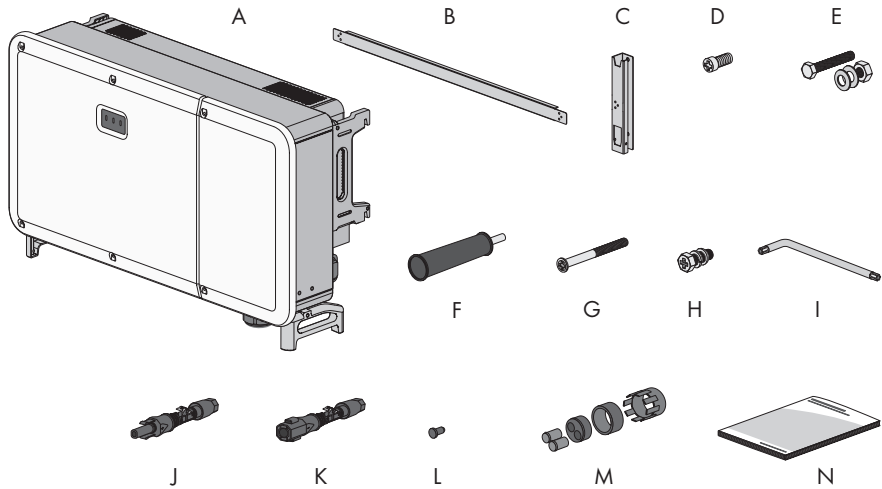

Position	Quantity	Designation
A	1	Inverter
B	1	Connecting rod for mounting bracket
C	2	Bracket part for mounting bracket
D	2	Cylindrical screw M4 x 10
E	4	M10x45 hex screw with 1 M10 washer, one M10 spring washer and one M10 hex nut
F	4	Carry handle
G	2	Pan head screw M5x65
H	2	M6x12 hex screw with 1 M6 washer and one M6 spring washer
I	1	TX30 internal Allen key
J	24	Positive DC connector
K	24	Negative DC connector
L	48	Sealing plug
M	2	Two-hole sealing block for communication terminal with inserts for cable diameters from 4.5 mm to 6 mm and 6 mm to 8 mm
N	1	Quick Reference Guide

## 4 Additionally Required Materials and Equipment

Material	Quantity	Explanation
Profile rail (length: min. 1100 mm, depth: max. 60 mm, height: 50 mm to 80 mm)	2	Required exclusively if the product is intended to be mounted using a profile rail
Threaded ring (M12)	2	Only required if the product is to be transported with a hoist
Heavy-duty anchor (M10x95)	4	Only required if mounted without profile rails: For mounting the device on a wall
Ring terminal lugs (M12)	4	To attach to the AC connection cables
Ethanol cleaning agent	1	Used to clean terminal lugs
Protective grease	1	Only required if cable is made of aluminum: Used to apply to aluminum conductor
Network cable(s)	1	To establish communication with the product
Field-assembly RJ45 connector.	2	Only required if self-assembly network cable is used
Equipment	Quantity	Explanation
Means of transport (e.g. pallet truck)	1	Used to transport packed product to mounting location
Hoist	1	Only required if the product is to be transported with a hoist
Utility knife	1	Used to unpack the product
Flat-blade screwdriver (4 mm)	1	For loosening the sealing screw on the attachment bars of the inverter
Phillips screwdriver (PH2)	1	For attaching the connecting rod at the bracket parts for the mounting bracket
Tape measure	1	For measuring the distances between bore holes for mounting
Marker pen	1	For marking the bore holes for mounting



Equipment	Quantity	Explanation
Hammer drill with Ø 12 mm and Ø 14 mm drill bit	1	For drilling the bore holes for mounting
Spirit level	1	For aligning the mounting bracket
Rubber mallet	1	Only required if mounted without profile rails: For securing the expanding screws for mounting
Wrench (AF16)	1	Only required if mounted with profile rails: For attaching the mounting bracket
Socket wrench with 16 mm insert	1	Only required if mounted with profile rails: For attaching the mounting bracket
Phillips screwdriver (PH3)	1	For attaching the product to the mounting bracket
Cable cutter	1	For trimming cables
Insulation stripping tool	1	For insulating the cable for the AC connection
Press tool	1	For attaching the ring terminal lugs to the cables of the AC connection
Hot-air blower	1	For attaching the heat-shrink tubings to the AC conductors
Clean cloth	1	Used to clean terminal lugs
Brush	1	Only required if mounted with profile rails: For cleaning the aluminum conductors
Wrench (AF33)	1	For loosening and attaching the swivel nut of the communication connection
Measuring device with a measurement range designed for the maximum AC and DC voltage of the inverter	1	For verifying that no voltage is present
Current clamp	1	For verifying that no current is present

## 5 Product Overview

### 5.1 Product Description

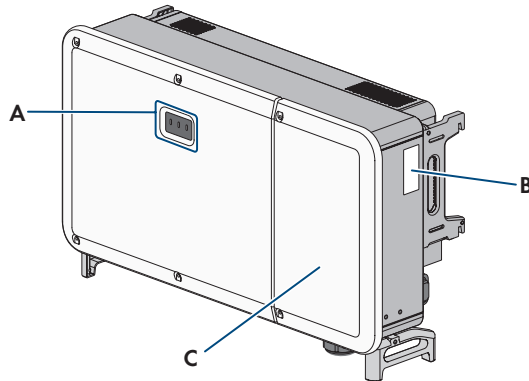















Figure 1: Design of the product

Position	Designation
A	LEDs The LEDs indicate the operating state of the product.
B	Type label The type label clearly identifies the product. The type label must remain permanently attached to the product. You will find the following information on the type label: <ul style="list-style-type: none"> <li>• Device type (Model)</li> <li>• Serial number (Serial No. or S/N)</li> <li>• Date of manufacture</li> <li>• Device-specific characteristics</li> </ul>
C	Cable compartment cover

### 5.2 Symbols on the Product

Icon	Explanation
	Beware of a danger zone This symbol indicates that the product must be additionally grounded if additional grounding or equipotential bonding is required at the installation site.
	Beware of electrical voltage The product operates at high voltages.

Icon	Explanation
	<p>Beware of hot surface</p> <p>The product can get hot during operation.</p>
	<p>Danger to life due to high voltages in the inverter; observe a waiting time of 5 minutes.</p> <p>High voltages that can cause lethal electric shocks are present in the live components of the inverter.</p> <p>Prior to performing any work on the inverter, disconnect it from all voltage sources as described in this document.</p>
	<p>Observe the documentations</p> <p>Observe all documentations supplied with the product.</p>
	<p>Inverter</p> <p>Together with the green LED, this symbol indicates the operating state of the inverter.</p>
	<p>Observe the documentations</p> <p>Together with the red LED, this symbol indicates an error.</p>
	<p>Data transmission</p> <p>Together with the blue LED, this symbol indicates the status of the network connection.</p>
	<p>Three-phase alternating current without neutral conductor</p>
	<p>Direct current</p>
	<p>The product has no galvanic isolation.</p>
	<p>WEEE designation</p> <p>Do not dispose of the product together with the household waste but in accordance with the disposal regulations for electronic waste applicable at the installation site.</p>
	<p>The product is suitable for outdoor installation.</p>

Icon	Explanation
<b>IP66</b>	Degree of protection IP66 The product is protected against the penetration of dust and water that is directed as a strong jet against the enclosure from all directions.
<b>CE</b>	CE marking The product complies with the requirements of the applicable EU directives.
<b>UK CA</b>	UKCA marking The product complies with the regulations of the applicable laws of England, Wales and Scotland.
	RoHS labeling The product complies with the requirements of the applicable EU directives.

## 5.3 Interfaces and Functions

### User interface for configuration and monitoring

The product is equipped as standard with an integrated webserver, which provides a user interface for configuring and monitoring the product.

Once the connection has been established to the smart device, use a terminal (e.g. smartphone, tablet or laptop) to connect to the product's user interface using a web browser.

### Modbus

The product is equipped with a Modbus interface. The inverter is delivered with the Modbus interface activated as standard.

The Modbus interface of the supported SMA products is designed for industrial use – via SCADA systems, for example – and has the following tasks:

- Communication of the inverter with the SMA Data Manager
- Remote query of measured values
- Remote setting of operating parameters
- Setpoint specifications for system control

### Grid management services

The product is equipped with service functions for grid management.

Depending on the requirements of the grid operator, you can activate and configure the functions (e.g. active power limitation) via operating parameters.

### SMA Smart Connected

SMA Smart Connected is the free monitoring of the product via the SMA Sunny Portal. Thanks to SMA Smart Connected, the operator and qualified person will be informed automatically and proactively about product events that occur.

SMA Smart Connected is activated during registration in Sunny Portal. In order to use SMA Smart Connected, it is necessary that the product is permanently connected to Sunny Portal and the data of the operator and qualified person is stored in Sunny Portal and up-to-date.

SMA Smart Connected can exclusively be used if the inverter is used in conjunction with an SMA Data Manager M.

## 5.4 LED Signals

The LEDs indicate the operating state of the product.

LED signal	Explanation
The green LED is flashing (two seconds on and two seconds off)	Waiting for feed-in conditions The conditions for feed-in operation are not yet met. As soon as the conditions are met, the inverter will start feed-in operation.
The green LED is glowing	Feed-in operation The inverter is feeding in.
The green LED is off	The inverter is not feeding into the utility grid.
The red LED is glowing	Event occurred If an event occurs, a distinct event message and the corresponding event number will be displayed in addition on the product user interface or in the communication product (e.g. SMA Data Manager).
The blue LED is glowing	Communication active There is an active connection with a local network or there is a direct connection via Ethernet with a smart end device (e.g. smartphone, tablet or laptop).

## 5.5 System Overview

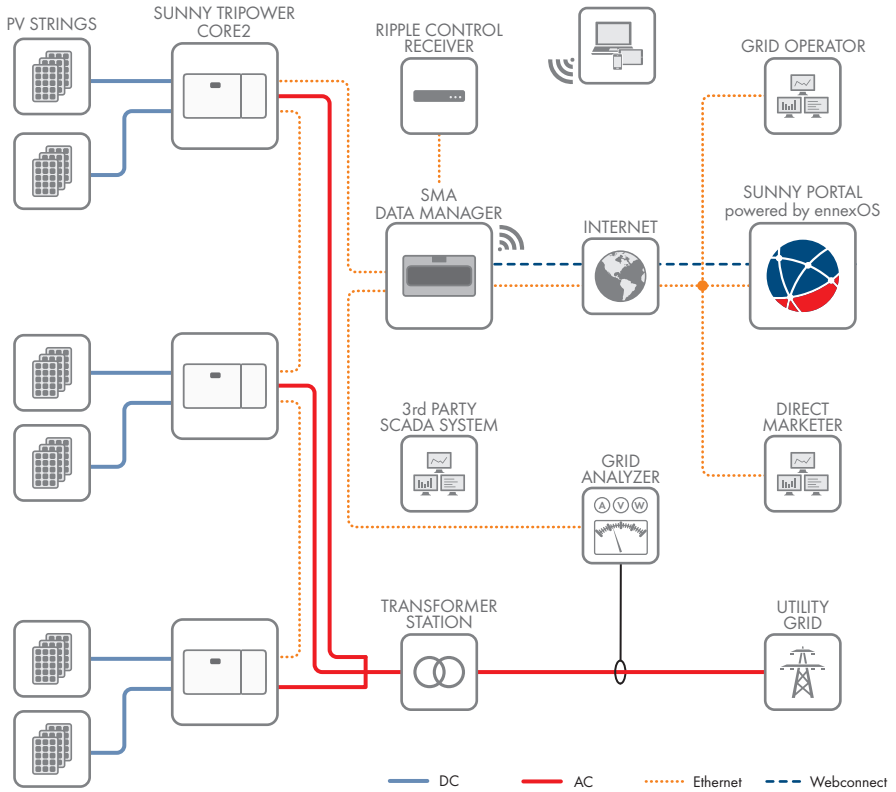

Figure 2: Design of the system

## 6 Mounting

### 6.1 Installing Optional AC Sealing Plate

An optional AC sealing plate with 4 cable glands can be used for the product. The optional AC sealing plate can be ordered in the SMA online shop ([www.sma-onlineshop.com](http://www.sma-onlineshop.com)) by indicating the material number 201013-00.01.

#### Procedure:

1. Loosen the 4 screws of the AC sealing plate attached to the inverter at delivery (TX30) and remove the AC sealing plate.

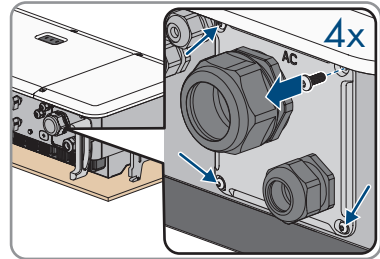

2. Ensure that the AC device opening is free of contamination.
3. Ensure that the seal of the optional AC sealing plate is undamaged and free of contamination.
4. Attach the optional AC sealing plate to the inverter using the 4 screws supplied (TX30, torque: 4.3 Nm).

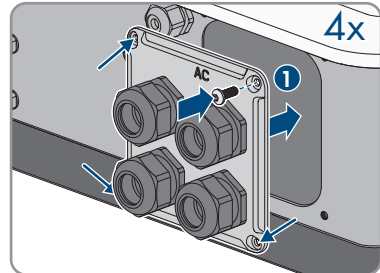

### 6.2 Requirements for Mounting

#### Requirements for the mounting location:

#### ⚠ WARNING

#### Danger to life due to fire or explosion

Despite careful construction, electrical devices can cause fires. This can result in death or serious injury.

- Do not mount the product in areas containing highly flammable materials or gases.
- Do not mount the product in potentially explosive atmospheres.

- Do not mount the inverter in living areas.
- Specialists must have exclusive access to the mounting location.

- A solid support surface must be available (e.g. concrete or masonry, free-standing constructions).
- The mounting location must not be exposed to direct solar irradiation. If the product is exposed to direct solar irradiation, the exterior plastic parts might age prematurely and overheating might occur. When becoming too hot, the product reduces its power output to avoid overheating.
- All ambient conditions must be met (see Section 16, page 77).

#### Permitted and prohibited mounting positions:

- The product may only be mounted in a permitted position. This will ensure that no moisture can penetrate the product.
- The product should be mounted such that the LED signals can be read off without difficulty.

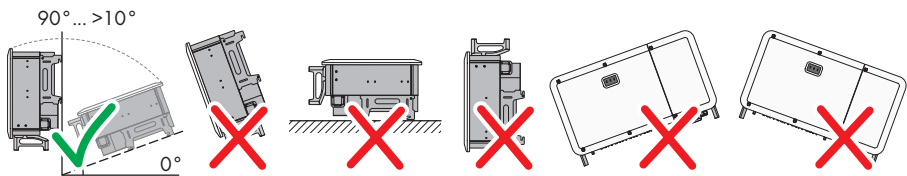

Figure 3: Permitted and prohibited mounting positions

#### Recommended clearances:

If you maintain the recommended clearances, adequate heat dissipation will be ensured. Thus, you will prevent power reduction due to excessive temperature.

- Maintain the recommended clearances to walls as well as to other inverters or objects.

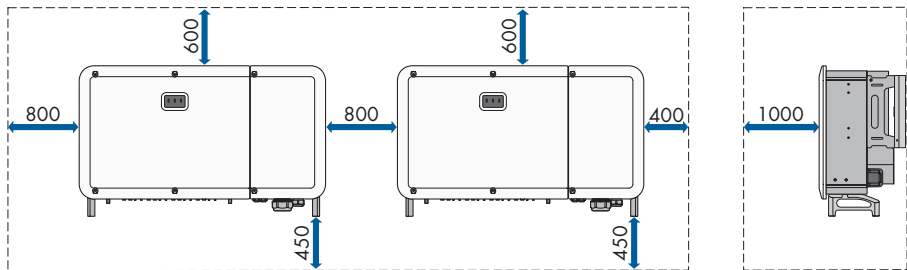

Figure 4: Recommended clearances (Dimensions in mm)

## 6.3 Mounting to Profile Rails

### 6.3.1 Requirements for mounting to profile rails

#### Requirements for the mounting location:

- At least 2 profile rails must be available for mounting.
- The support surface of the frame to which the profile rails are attached should be firm and level (e.g. concrete). Non-fulfillment of these criteria may restrict servicing.



**Requirements for the profile rails:**

- The profile rails must be designed for the load and orientation of the inverters in the PV system. The profile rails might need to be reinforced.
- The spacing of the profile rails must be designed for the spacing of the holes in the bracket parts for the mounting bracket.

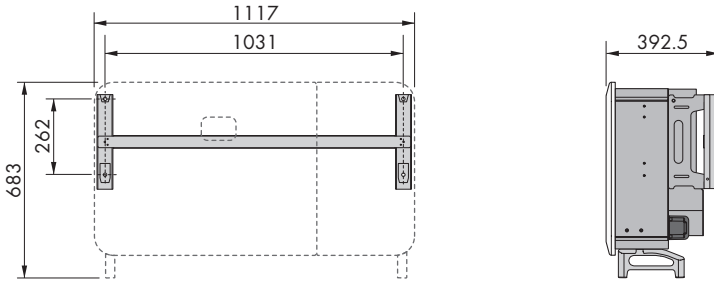

Figure 5: Dimensions of the mounting bracket (dimensions in mm)

### 6.3.2 Mounting the Product to Profile Rails

#### **⚠ QUALIFIED PERSON**

#### **⚠ CAUTION**

##### **Risk of injury due to weight of product**

Injuries may result if the product is lifted incorrectly or dropped while being transported or mounted.

- Transport and lift the product carefully. Take the weight of the product into account.
- Wear suitable personal protective equipment for all work on the product.
- Transport the product using the carrying handles or hoist. Take the weight of the product into account.
- Use all carrying handles provided during transport with carrying handles.
- Do not use the carrying handles as attachment points for hoist equipment (e.g. straps, ropes, chains). Insert eye bolts into threads provided on top of the product to attach the hoist system.

**Procedure:**

1. Screw the bracket parts to the ends of the connecting rod (PH2, torque: 1.5 Nm) using the cheese head screws (M4x10) to mount the mounting bracket.

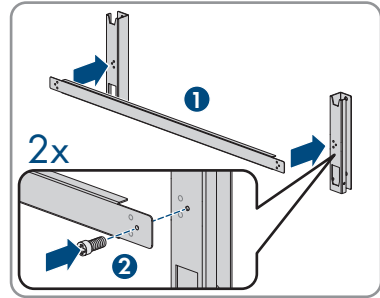

2. Align the mounting bracket using a spirit level and mark the drilling positions on the profile rails.
3. Drill the bore holes ( $\varnothing$  12 mm) at the marked areas.
4. Attach the mounting bracket to the profile rails (WAF16, torque: 35 Nm) using 4 hex screws (M10x45). In this process, use 1 washer, 1 spring washer and 1 hex nut each.

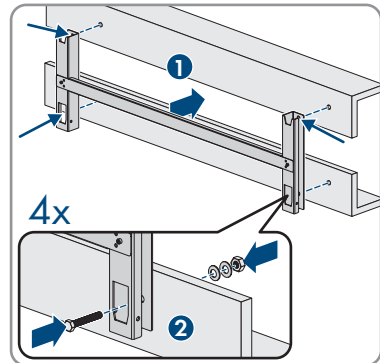

5. Remove the sealing screws on the sides of the inverter using a flat-blade screwdriver (4 mm).

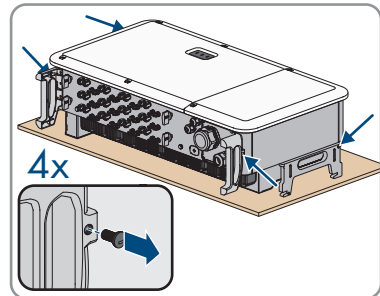

6. If the inverter is to be hooked into the mounting bracket using a hoist, screw the eye bolts into the 2 upper tapped holes on the right-hand and left-hand side of the inverter and attach the hoist to them. The hoist must be suitable to take the weight of the inverter.

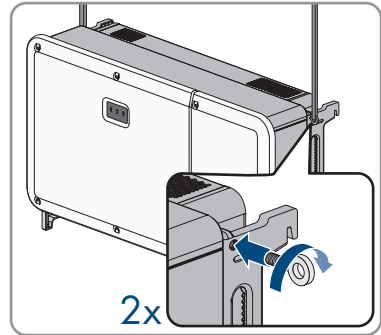

7. If the inverter is to be hooked into the mounting bracket without using a hoist, screw the transport handles as far as they will go into the tapped holes on the right-hand and left-hand side until they lie flush with the enclosure. When doing so, ensure that the transport handles are screwed into the tapped holes so that they are perfectly straight. If the transport handles are not screwed in straight, this can make it more difficult or even impossible to unscrew them later on and can damage the tapped holes to the extent that transport handles can no longer be screwed into them.

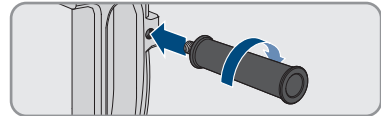

8. Hook the inverter into the mounting bracket.

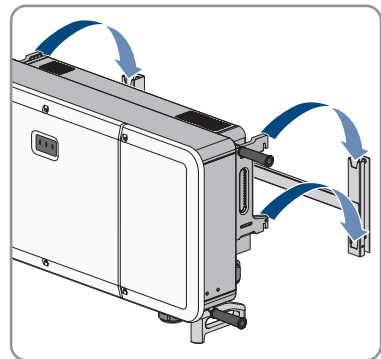

9. Remove all 4 transport handles from the tapped holes or remove the eye bolts of the hoist and again screw in the sealing screws using a flat-blade screwdriver (4 mm, torque 2 Nm).

10. Use the pan head screws (M5x65) to attach the inverter to the mounting bracket (PH3, torque: 4.5 Nm).

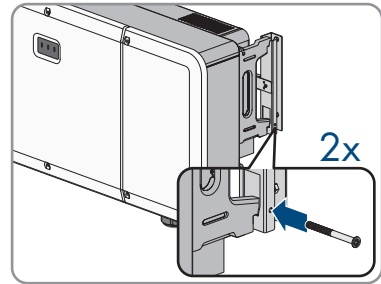

## 6.4 Mounting the Product on a Wall

### ⚠ QUALIFIED PERSON

### ⚠ CAUTION

#### Risk of injury due to weight of product

Injuries may result if the product is lifted incorrectly or dropped while being transported or mounted.

- Transport and lift the product carefully. Take the weight of the product into account.
- Wear suitable personal protective equipment for all work on the product.
- Transport the product using the carrying handles or hoist. Take the weight of the product into account.
- Use all carrying handles provided during transport with carrying handles.
- Do not use the carrying handles as attachment points for hoist equipment (e.g. straps, ropes, chains). Insert eye bolts into threads provided on top of the product to attach the hoist system.

#### Additionally required material (not included in the scope of delivery):

- 4 heavy-duty anchors

#### Procedure:

1. Screw the bracket parts to the ends of the connecting rod (PH2, torque: 1.5 Nm) using the cheese head screws (M4x10) to mount the mounting bracket.

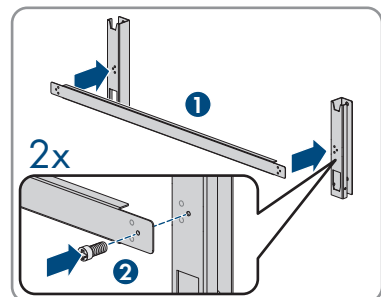

2. Align the mounting bracket using a spirit level and mark the drilling positions.

3. Drill the bore holes ( $\varnothing$  12 mm) at the marked areas.
4. Attach the mounting bracket to the wall using the heavy-duty anchors.
5. Remove the sealing screws on the sides of the inverter using a flat-blade screwdriver (4 mm).

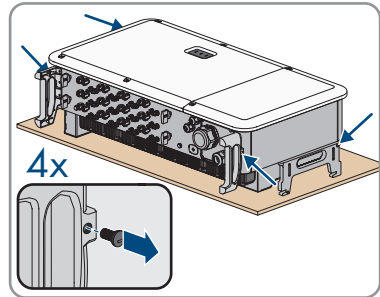

6. If the inverter is to be hooked into the mounting bracket using a hoist, screw the eye bolts into the 2 upper tapped holes on the right-hand and left-hand side of the inverter and attach the hoist to them. The hoist must be suitable to take the weight of the inverter.

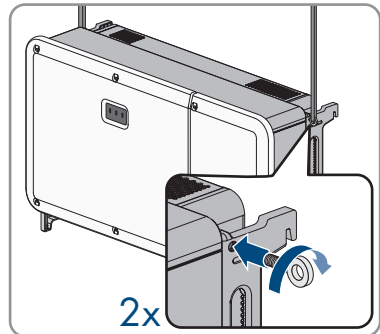

7. If the inverter is to be hooked into the mounting bracket without using a hoist, screw the transport handles as far as they will go into the tapped holes on the right-hand and left-hand side until they lie flush with the enclosure. When doing so, ensure that the transport handles are screwed into the tapped holes so that they are perfectly straight. If the transport handles are not screwed in straight, this can make it more difficult or even impossible to unscrew them later on and can damage the tapped holes to the extent that transport handles can no longer be screwed into them.

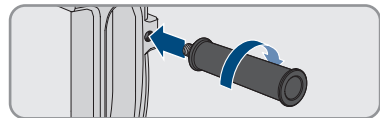

8. Hook the inverter into the mounting bracket.

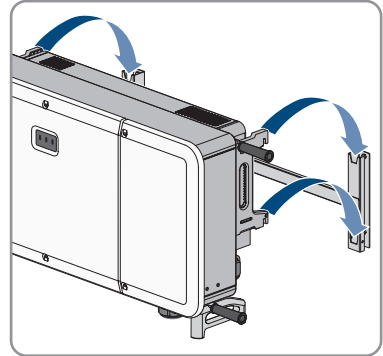

9. Remove all 4 transport handles from the tapped holes or remove the eye bolts of the hoist and and once again screw in the sealing screws (flat-blade screwdriver 4 mm, torque: 2 Nm).

10. Use the pan head screws (M5x65) to attach the inverter to the mounting bracket (PH3, torque: 4.5 Nm).

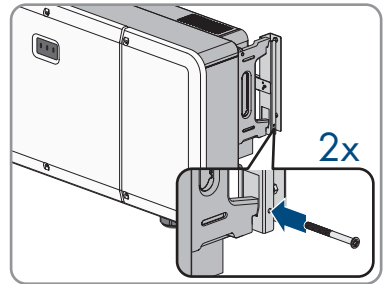

## 7 Opening the Cable Compartment

### **⚠ QUALIFIED PERSON**

For some of the actions described in this document, the cable compartment must be opened.

#### Procedure:

1.

### **⚠ DANGER**

#### **Danger to life due to electric shock**

- Disconnect the inverter from all voltage sources (see Section 11, page 55).

2. Loosen the 2 screws on the cable compartment cover using the enclosed internal Allen key (TX30) and open the cable compartment.

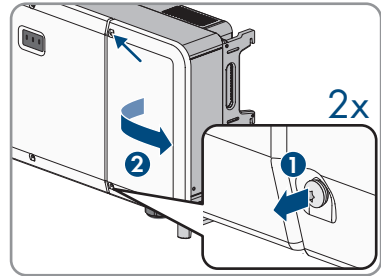

3. Lift the limiting lever on the inside of the cover on the right and remove from the thread.

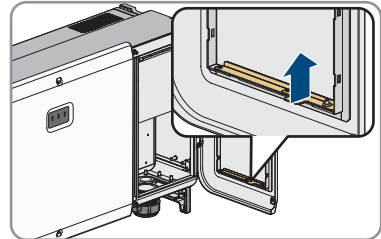

4. Fold the limiting lever on the joint and turn it towards the cable compartment.

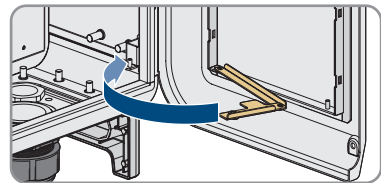

5. Engage the end of the limiting lever in the cable compartment with the thread.

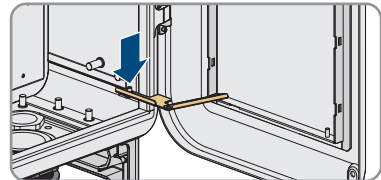

- The cable compartment cover has been secured and remains open.

## 8 Electrical Connection

### 8.1 Overview of the Connection Area

#### 8.1.1 View from Below

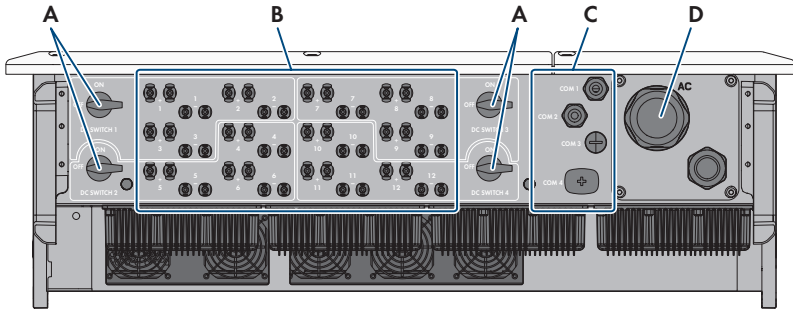

Figure 6: Enclosure openings at the bottom of the inverter

Position	Designation
A	DC load-break switch
B	Positive and negative connectors for DC connection
C	Cable gland for connecting the communication
D	Cable gland for the AC connection

#### 8.1.2 Interior View

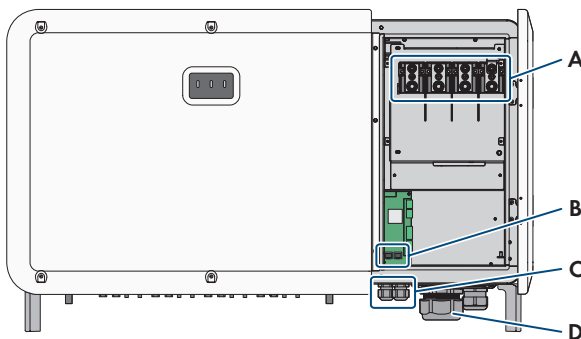

Figure 7: Connection areas in the interior of the inverter

Position	Designation
A	AC connection area



Position	Designation
B	Connection for Ethernet communication
C	Cable gland for connecting the communication
D	Cable gland for the AC connection

## 8.2 AC Connection

### 8.2.1 Requirements for the AC Connection

#### AC cable requirements as follows:

- Conductor type: aluminum and copper wire
- When using conductors made of aluminum wire, bimetal terminal lugs made of aluminum and copper must be used to prevent direct contact of the copper bar with the aluminum wire.
- External diameter: 38 mm to 56 mm
- Outside diameter of each AC cable when using the optional AC sealing plate: 14 mm to 32 mm
- Conductor cross-section: 70 mm<sup>2</sup> to 240 mm<sup>2</sup>
- Conductor cross-section of grounding conductor: 35 mm<sup>2</sup> to 240 mm<sup>2</sup>
- Insulation stripping length: 30 mm
- Sheath stripping length: ≤ 375 mm
- The cable must be dimensioned in accordance with the local and national directives for the dimensioning of cables. The requirements for the minimum wire size derive from these directives. Examples of factors influencing cable dimensioning are: nominal AC current, type of cable, routing method, cable bundling, ambient temperature and maximum desired line losses (for calculation of line losses, see the design software "Sunny Design" from software version 2.0 at [www.SMA-Solar.com](http://www.SMA-Solar.com)).

#### Residual-current monitoring unit:

The inverter does not require an external residual-current device when operating. If local regulations require the use of a residual-current device, the following must be observed:

- The inverter is compatible with type B residual-current devices with a rated residual current of 1100 mA or higher (see Technical Information "Criteria for Selecting a Residual-Current Device" in [www.SMA-Solar.com](http://www.SMA-Solar.com) for information on how to select a residual-current device). Each inverter in the system must be connected to the utility grid via a separate residual-current device.
- When using residual-current device with a lower rated residual current, there is a risk of false tripping of the residual-current device, depending on the system design.

**Overvoltage category:**

The product can be used in grids of overvoltage category III or lower in accordance with IEC 60664-1. That means that the product can be permanently connected to the grid-connection point of a building. In case of installations with long outdoor cabling routes, additional measures to reduce overvoltage category IV to overvoltage category III are required (see the Technical Information "Overvoltage Protection" at [www.SMA-Solar.com](http://www.SMA-Solar.com)).

**8.2.2 Connecting the Inverter to the Utility Grid****⚠ QUALIFIED PERSON****Requirements:**

- The connection requirements of the grid operator must be met.
- The grid voltage must be within the permissible range. The exact operating range of the inverter is specified in the operating parameters.

**Required material (not included in the scope of delivery):**

- Protective grease (only for conductors made of aluminum)
- 4 heat-shrink tubings
- 4 ring terminal lugs with hole diameter 12 mm (for conductors made of aluminum bimetal terminal lugs made of aluminum and copper)

**Procedure:**

1. Disconnect the AC miniature circuit breaker from all 3 line conductors and secure against reconnection.
2. Ensure that all 4 DC load-break switches have been switched off and been secured against reconnection.

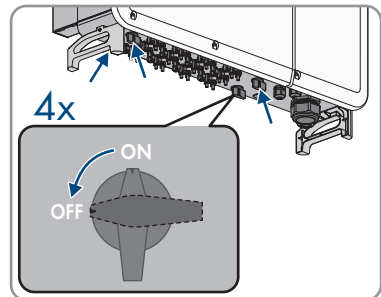

3. Open the cable compartment (see Section 7, page 31).
4. Dismantle the AC cable ( $\leq 375$  mm).  
If the optional AC sealing plate is used, dismantle all 4 cables.
5. Strip the insulation of L1, L2, L3 and the grounding conductor (30 mm).

6. For conductors made of aluminum, remove the oxide film and apply protective grease to the conductors.

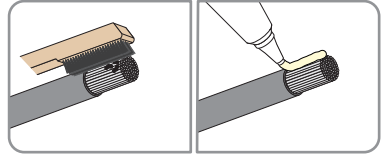

7. Loosen the 4 screws of the protective cover in front of the AC connection (PH2) and remove the protective cover.

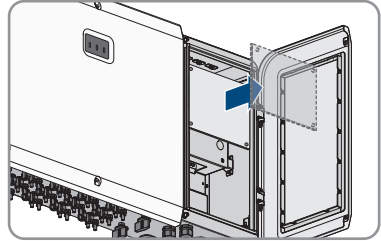

8. Loosen the swivel nut of the cable gland for the AC connection on the bottom of the inverter. Loosen all 4 swivel nuts when using the optional AC sealing plate.

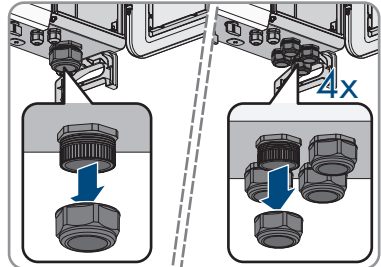

9. Remove the additional seal insert of the cable gland of the AC terminal when using cables with a diameter  $\geq 47$  mm. Lead the cable through the swivel nut and the cable gland into the device. When using the optional AC sealing plate with a cable diameter of  $\geq 22$  mm, remove the additional sealing inserts of the cable glands. Feed the 4 cables through 1 swivel nut and 1 cable gland each into the device.

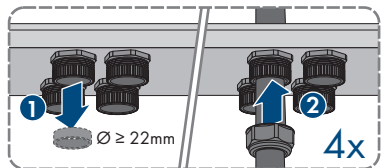
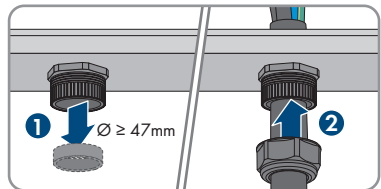

10. Pull 1 heat-shrink tubing each over conductors L1, L2, L3 and the grounding conductor. The heat-shrink tubing must be below the stripped conductor section.

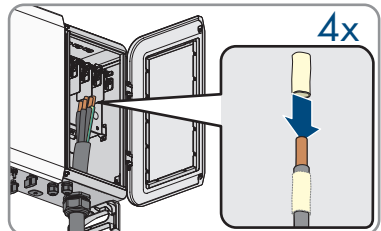

11. Insert the stripped conductor section into the ring terminal lugs and crimp using a crimping tool.

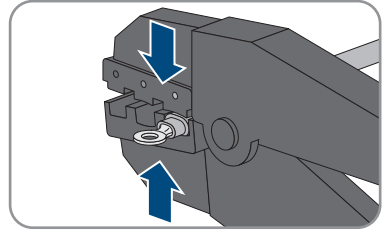

12. Pull the heat-shrink tubings onto the crimped section of the ring terminal lugs and using a hot-air blower shrink them so that they are in firm contact with the ring terminal lugs.

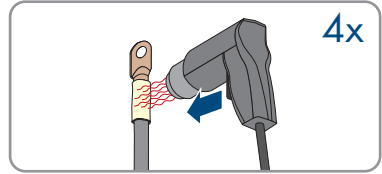

13. Hook the conductors with the ring terminal lugs as labeled for L1, L2, L3 and the grounding conductor onto the threads at the top of the cable compartment.

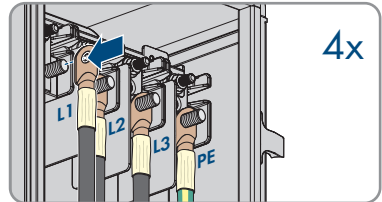

14. Install 1 washer each and tighten the hex nut using a ratchet (AF19, torque: 20 to 30 Nm).

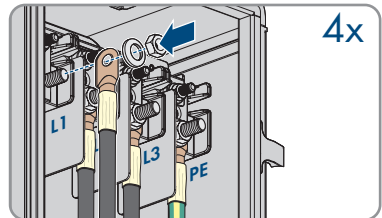

15. Tighten the swivel nut to the cable gland of the AC connection (SW83, torque: 15 Nm to 19 Nm). Ensure that the AC cable is not under tension.  
Tighten all 4 swivel nuts when using the optional AC sealing plate (SW53, torque: 10 Nm to 13 Nm). Ensure that the AC cables are not under tension.
16. Attach the protective cover in front of the AC connection using the 4 screws (PH2, torque: 1.5 Nm).
17. Move the limiting lever back to its original position and close the cable compartment cover.

18. Tighten the 2 screws on the cable compartment cover (TX30, torque: 4.3 Nm).

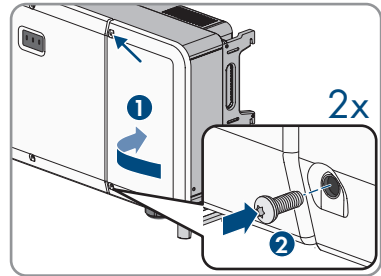

### 8.2.3 Connecting the Grounding

#### ⚠ QUALIFIED PERSON

An additional grounding of the inverter is required to protect from touch current in case the grounding conductor fails at the terminal of the AC cable.

The inverter features a grounding terminal with 2 connection points for grounding (e.g. when using a grounding electrode).

The connection points have been labeled with the following symbol: ⊕

The required M6x12 screw with spring washer and washer is included in the scope of delivery of the inverter.

#### Additionally required material (not included in the scope of delivery):

- 1 grounding cable
- 1 ring terminal lug M6
- 1 heat-shrink tubing

#### Cable requirement:

- Cross-section of the grounding cable: at least 10 mm<sup>2</sup> if a copper cable is used, at least 16 mm<sup>2</sup> if an aluminum cable is used

#### Procedure:

1. Strip the grounding cable insulation.
2. Pull the heat-shrink tubing over the grounding cable. The heat-shrink tubing must be below of the stripped cable section.

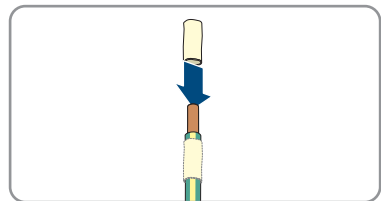

3. Insert the stripped section of the grounding cable into the ring terminal lug and crimp using a crimping tool.

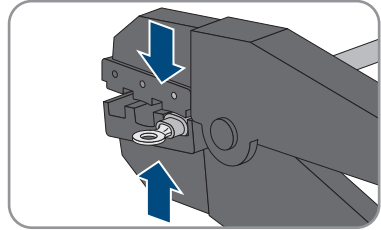

4. Pull the heat-shrink tubing onto the crimped section of the ring terminal lug and using a hot-air blower shrink them so that they are in firm contact with the ring terminal lugs.

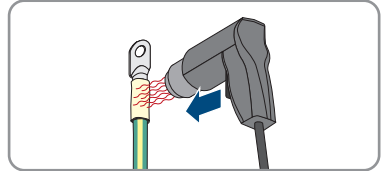

5. Plug washer and spring washer onto the hex head screw and tighten the hex head screw to one of the 2 connection points for additional grounding (PH3, torque: 6 Nm to 7 Nm).

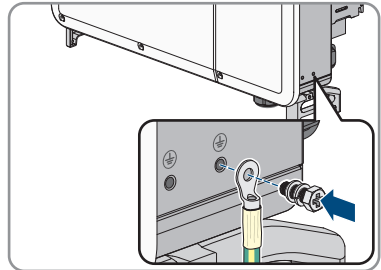

## 8.3 Connecting the Network Cables

### ⚠ QUALIFIED PERSON

### ⚠ DANGER

#### Danger to life due to electric shock in case of overvoltages and if surge protection is missing

Overtages (e. g. in the event of a flash of lightning) can be further conducted into the building and to other connected devices in the same network via the network cables or other data cables if there is no surge protection. Touching live parts and cables results in death or lethal injuries due to electric shock.

- Ensure that all devices in the same network are integrated in the existing overvoltage protection.
- When laying the network cable outdoors, ensure that there is suitable surge protection at the network cable transition from the product outdoors to the network inside the building.

#### Additionally required material (not included in the scope of delivery):

- Network cable(s)
- Where required: Field-assembly RJ45 connector.

**Network cable requirements:**

The cable length and quality affect the quality of the signal. Observe the following cable requirements:

- Cable type: 100BaseTx
- Cable category: minimum CAT5e
- Plug type: RJ45 of Cat5, Cat5e or higher
- Shielding: SF/UTP, S/UTP, SF/FTP or S/FTP
- Number of insulated conductor pairs and insulated conductor cross-section: at least 2 x 2 x 0.22 mm<sup>2</sup>
- Maximum cable length between 2 nodes when using patch cables: 50 m
- Maximum cable length between 2 nodes when using installation cables: 100 m
- UV-resistant for outdoor use.

**Procedure:**

1. Open the cable compartment (see Section 7, page 31).
2. When using a self-assembly network cable, assemble the RJ45 connectors and connect them to the network cable (see connector documentation).
3. Remove the swivel nut from one of the cable glands for the communication cable.

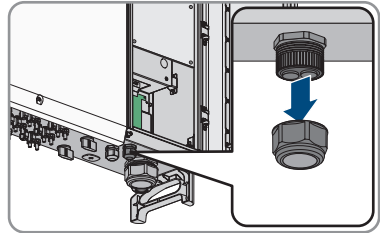

4. Thread the swivel nut over the network cable.
5. Remove the two-hole cable support sleeve from the cable gland. As required, use the cable support sleeve for a cable diameter of between 4.5 mm to 6 mm or between 6 mm to 8 mm that is included in the scope of delivery.
6. Remove the sealing plug from one of the enclosure openings of the two-hole cable support sleeve and insert the network cable into the enclosure opening.

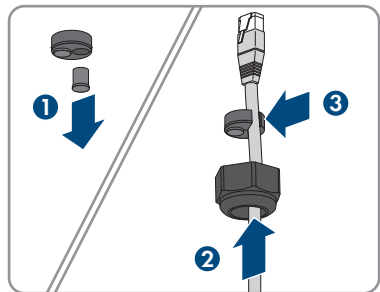

7. Press the two-hole cable support sleeve with the cable into the cable gland and route the network cable to the RJ45 connection at the bottom of the cable compartment. Ensure that any unused enclosure openings of the two-hole cable support sleeve are sealed with sealing plugs.

8. Put the RJ45 plug of the cable into one of the network jacks of the communication assembly.

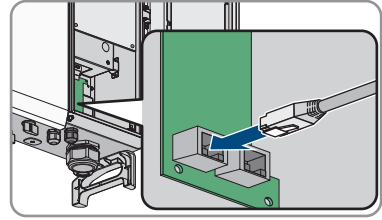

9. Ensure that the network cable does not form any loops in the device and is no longer than necessary.

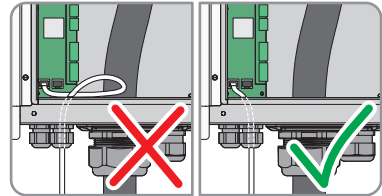

10. Ensure that the RJ45 connector is firmly seated and that there is no tension on the cable.
11. Tighten the swivel nut on the cable gland hand-tight. This will secure the network cable in place.
12. If the inverter is installed outdoors, install overvoltage protection for all components in the network.
13. To integrate the inverter into a local network, connect the other end of the network cable to the local network (e.g. via a router).

## 8.4 DC Connection

### 8.4.1 Assembling the DC Connectors

#### **⚠ QUALIFIED PERSON**

#### **⚠ DANGER**

#### **Danger to life due to electric shock when live components or DC cables are touched**

When exposed to light, the PV modules generate high DC voltage which is present in the DC cables. Touching live DC cables results in death or lethal injuries due to electric shock.

- Do not touch non-insulated parts or cables.
- Disconnect the product from voltage sources and ensure it cannot be reconnected before working on the device.
- Do not disconnect the DC connectors under load.
- Wear suitable personal protective equipment for all work on the product.



## NOTICE

### Destruction of the inverter due to overvoltage

If the open-circuit voltage of the PV modules exceeds the maximum input voltage of the inverter, the inverter can be destroyed due to overvoltage.

- If the open-circuit voltage of the PV modules exceeds the maximum input voltage of the inverter, do not connect any strings to the inverter and check the design of the PV system.

For connection to the inverter, all PV module connection cables must be fitted with the DC connectors provided. Assemble the DC connectors as described in the following. The procedure is identical for both connectors (+ and -). The graphics for the procedure are shown for only the positive connector as an example. Pay attention to the correct polarity when assembling the DC connectors. The DC connectors are marked with the symbols "+" and "-".

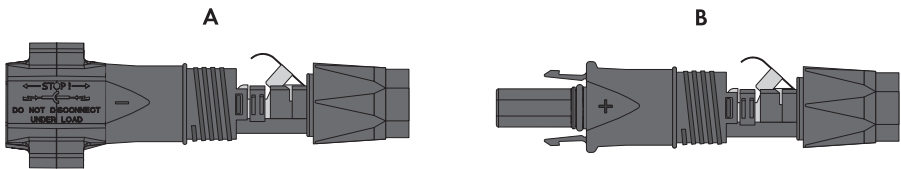

Figure 8: Negative (A) and positive (B) DC connectors

### Cable requirements:

- External diameter: 5.5 mm to 8 mm
- Conductor cross-section: 2.5 mm<sup>2</sup> to 6 mm<sup>2</sup>
- Qty single wires: minimum 7
- Nominal voltage: minimum 1000 V
- Using bootlace ferrules is not allowed.

### Procedure:

1. Strip approx. 15 mm of the cable insulation.
2. Insert the stripped cable into the DC connector up to the stop. When doing so, ensure that the stripped cable and the DC connector are of the same polarity.
3. Press the clamping bracket down until it audibly snaps into place.

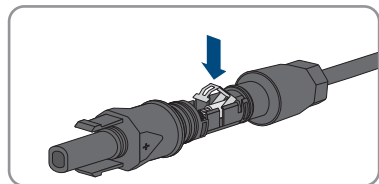
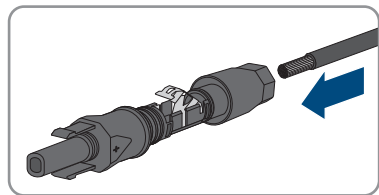

- ☑ The stranded wire can be seen inside the clamping bracket chamber.

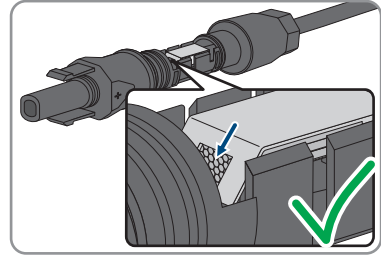

4. If the stranded wire is not visible in the chamber, the cable is not correctly inserted and the connector must be reassembled. To do this, the cable must be removed from the connector.

- Release the clamping bracket. To do so, insert a screwdriver (blade width: 3.5 mm) into the clamping bracket and pry the clamping bracket open.

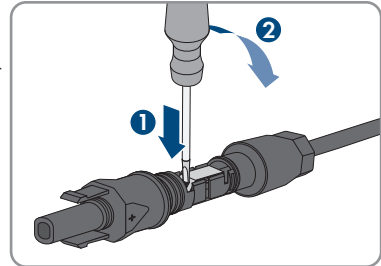

- Remove the cable and go back to step 2.

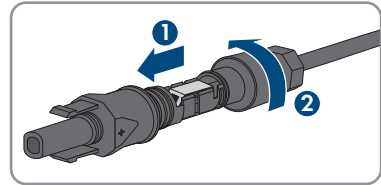

5. Push the swivel nut up to the thread and tighten (torque: 2 Nm).

## 8.4.2 Connecting the PV Array

### ⚠ QUALIFIED PERSON

### ⚠ DANGER

#### Danger to life due to electric shock when live components or DC cables are touched

When exposed to light, the PV modules generate high DC voltage which is present in the DC cables. Touching live DC cables results in death or lethal injuries due to electric shock.

- Do not touch non-insulated parts or cables.
- Disconnect the product from voltage sources and ensure it cannot be reconnected before working on the device.
- Do not disconnect the DC connectors under load.
- Wear suitable personal protective equipment for all work on the product.

## ⚠ WARNING

### Danger to life due to electric shock from destruction of the measuring device due to overvoltage

Overvoltage can damage a measuring device and result in voltage being present in the enclosure of the measuring device. Touching the live enclosure of the measuring device results in death or lethal injuries due to electric shock.

- Only use measuring devices with a DC input voltage range of 1100 V or higher.

## NOTICE

### Damage to the product due to ground fault on DC side during operation

Due to the transformerless topology of the product, the occurrence of ground faults on DC side during operation can lead to irreparable damage. Damages to the product due to a faulty or damaged DC installation are not covered by warranty. The product is equipped with a protective device that checks whether a ground fault is present during the starting sequence. The product is not protected during operation.

- Ensure that the DC installation is carried out correctly and no ground fault occurs during operation.

## NOTICE

### Destruction of the inverter due to overvoltage

If the open-circuit voltage of the PV modules exceeds the maximum input voltage of the inverter, the inverter can be destroyed due to overvoltage.

- If the open-circuit voltage of the PV modules exceeds the maximum input voltage of the inverter, do not connect any strings to the inverter and check the design of the PV system.

#### Procedure:

1. Ensure that the AC miniature circuit breaker is switched off and that it cannot be reconnected.
2. Switch off the inverter's 4 DC load-break switches.

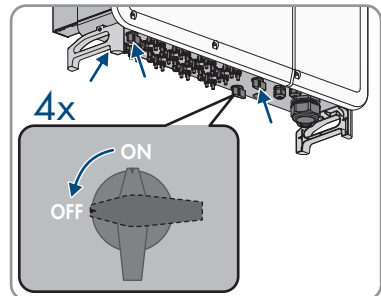

3. Measure the PV array voltage. Ensure that the maximum input voltage of the inverter is adhered to and that there is no ground fault in the PV array.

4. Check whether the DC connectors have the correct polarity.

If the DC connector is equipped with a DC cable of the wrong polarity, the DC connector must be reassembled. The DC cable must always have the same polarity as the DC connector.

5. Ensure that the open-circuit voltage of the PV array does not exceed the maximum input voltage.
6. Connect the assembled DC connectors to the inverter.

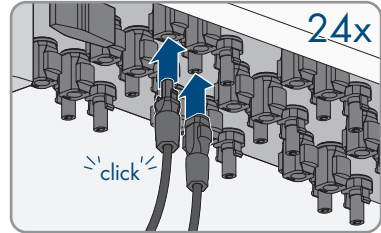

- ☑ The DC connectors snap into place.

7. Ensure that all DC connectors are securely in place.

8.

**NOTICE**

**Damage to the product due to sand, dust and moisture ingress if the DC inputs are not closed**

The product is only properly sealed when all unused DC inputs are closed with DC connectors and sealing plugs. Sand, dust and moisture penetration can damage the product and impair its functionality.

- Seal all unused DC inputs using the DC connectors and sealing plugs as described in the following. When doing so, do not plug the sealing plugs directly into the DC inputs on the inverter.

9. For unused DC connectors, push down the clamping bracket and push the swivel nut up to the thread.

10. Insert the sealing plug into the DC plug connector.

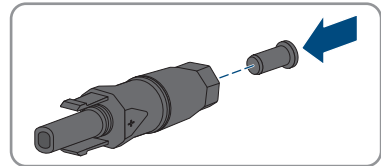

11. Insert the DC connectors with sealing plugs into the corresponding DC inputs on the inverter.

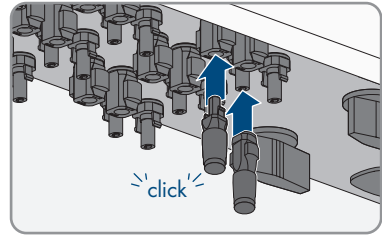

- ☑ The DC connectors snap into place.

12. Ensure that the DC connectors with sealing plugs are securely in place.

### 8.4.3 Disassembling the DC Connectors

#### ⚠ QUALIFIED PERSON

To disassemble the DC connectors for connection to the pv modules (e.g. due to faulty assembly), proceed as follows.

#### ⚠ DANGER

#### **Danger to life due to electric shock when touching exposed DC conductors or DC plug contacts if the DC connectors are damaged or loose**

The DC connectors can break or become damaged, become free of the DC cables, or no longer be connected correctly if the DC connectors are released and disconnected incorrectly. This can result in the DC conductors or DC plug contacts being exposed. Touching live DC conductors or DC plug connectors will result in death or serious injury due to electric shock.

- Wear insulated gloves and use insulated tools when working on the DC connectors.
- Ensure that the DC connectors are in perfect condition and that none of the DC conductors or DC plug contacts are exposed.
- Carefully release and remove the DC connectors as described in the following.

#### Procedure:

1. Release and remove the DC connectors. To do so, insert a flat-blade screwdriver or an angled screwdriver (blade width: 3.5 mm) into one of the side slots and pull the DC connectors out. When doing so, do not lever the DC connectors out, but insert the tool into one of the side slots only to release the locking mechanism, and do not pull on the cable.

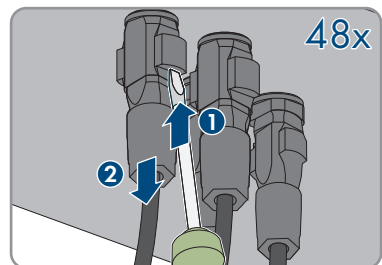

2. Remove the DC connector swivel nut.

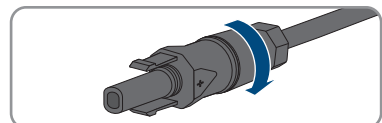

3. Unlock the DC connector. To do this, insert a flat-blade screwdriver (blade width: 3.5 mm) into the side catch mechanism and pry the catch mechanism open.

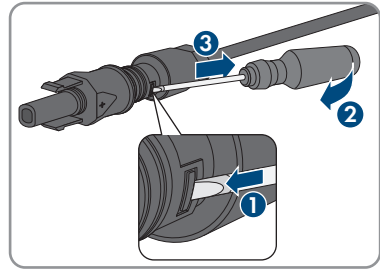

4. Carefully pull the DC connector apart.
5. Release the clamping bracket. To do so, insert a flat-blade screwdriver (blade width: 3.5 mm) into the clamping bracket and pry the clamping bracket open.

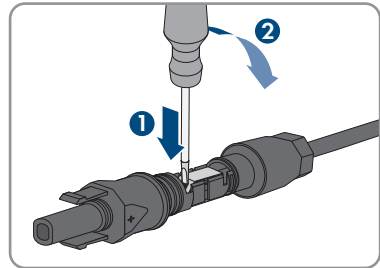

6. Remove the cable.

## 9 Commissioning

### 9.1 Commissioning Procedure

#### QUALIFIED PERSON

This section describes the commissioning procedure and gives an overview of the steps you must perform in the prescribed order.

#### Commissioning an inverter that is captured in a communication device

When the inverter is captured in a communication device, the communication device (e.g. SMA Data Manager) is the unit for configuring the total system. The configuration is transferred to all inverters in the system.

- Commission the inverter (see Section 9.2, page 47).
- The initial configuration of the inverter is made via the communication device. The configuration is transferred to the inverter and the settings of the inverter are overwritten.

Procedure	See
1. Commission the inverter.	Section 9.2, page 47
2. Establish a connection to the user interface of the inverter. There are various connection options to choose from for this: <ul style="list-style-type: none"> <li>• Direct connection via Ethernet</li> <li>• Connection via Ethernet in the local network</li> </ul>	Section 10.1, page 49
3. Log into the user interface.	Section 10.2, page 50
4. Configure the product and set country data set. Then the product will begin operation.	Section 10.6, page 53
5. Make further inverter settings as needed.	Section 10, page 49

### 9.2 Commissioning the Inverter

#### QUALIFIED PERSON

#### Requirements:

- The AC circuit breaker must be correctly rated and mounted.
- The product must be correctly mounted.
- All cables must be correctly connected.
- Unused enclosure openings must be sealed tightly with sealing plugs.

**Procedure:**

1. Close the cable compartment and tighten the screws on the cable compartment cover (TX 30, torque: 4.3 Nm).

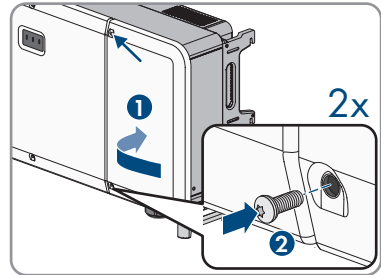

2. Switch on all 4 DC load-break switches.

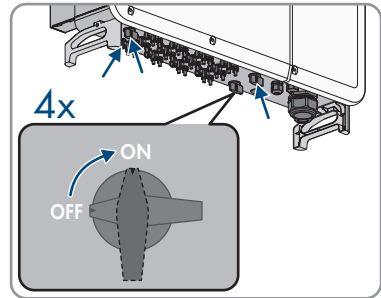

3. Switch on the AC circuit breaker.

- Green LED is flashing. The inverter is waiting for the input conditions.
  - After approx. 90 seconds, the green LED is permanently on. The inverter is feeding in.
4. If the green LED is still flashing after 90 seconds, the conditions for activating feed-in operation are not yet met. As soon as the conditions for feed-in operation are met, the inverter starts with the feed-in operation and the green LED will light up continuously.
  5. If the red LED lights up, an event has occurred. Use the event number to find out which event has occurred and, if necessary, initiate countermeasures.
  6. Ensure that the inverter feeds in correctly.



# 10 Operation

## 10.1 Establishing a connection to the user interface

### 10.1.1 Establishing a Direct Connection via Ethernet

#### Requirements:

- The product must be commissioned.
- A smart device (e.g. laptop) with an Ethernet interface must be available.
- The product must be connected directly to the smart device.
- One of the following web browsers must be installed on the smart device: Chrome (version 65 or higher), Internet Explorer (version 11 or higher) or Safari (version 11 or higher).

#### IP address of the inverter

- Standard inverter IP address for the direct connection via Ethernet: **169.254.12.3**

#### Procedure:

- Open the web browser of your smart device and enter the IP address **169.254.12.3** in the address bar.
- The login page of the user interface opens.

### 10.1.2 Establishing a Connection via Ethernet in the local network

#### New IP address for connecting with a local network

If the product is connected to a local network (e.g. via a router), the product will receive a new IP address. Depending on the type of configuration, the new IP address will be assigned automatically by the DHCP server (router) or manually by you. Upon completion of the configuration, the product can only be reached via the following access addresses:

- Generally applicable access address: IP address manually assigned or assigned by the DHCP server (router) (identification via network scanner software or network configuration of the router).
- Access address for Apple, Android, Windows and Linux systems: **SMA[serial number].local** (e.g. SMAA2102031234.local)

#### Requirements:

- The product must be connected to the local network via a network cable (e.g. via a router).
- The product must be integrated into the local network.
- A smart device (e.g. smartphone, tablet or laptop) must be available.
- The smart device must be in the same local network as the product.
- One of the following web browsers must be installed on the smart device: Chrome (version 65 or higher), Internet Explorer (version 11 or higher) or Safari (version 11 or higher).

**Procedure:**

- Open the web browser of your smart device. Enter the IP address of the product in the address bar of the web browser.
- The login page of the user interface opens.

## 10.2 Logging In and Out of the User Interface

After a connection to the user interface of the inverter has been established, the login page opens. Log onto the user interface as described below.

### **i** Usage of cookies

For the correct display of the user interface, cookies are required. The cookies are used for convenience only. By using this user interface you agree to the placement of cookies.

#### NOTICE

##### **Property damage due to unauthorized access to the system when the standard password is used**

The standard password of the product is publically available. If you use the standard password, unauthorized access to your system can be gained. Yield losses and system damage can arise as a result of unauthorized access.

- Replace the standard password with a secure password immediately.

#### NOTICE

##### **Property damage due to unauthorized access to adjustable parameters**

All adjustable parameters are protected by the password of the user group **Installer**. Providing the password to unauthorized persons can lead to incorrect parameters being input, resulting in damage to devices and system malfunctions. The user group **User** does not require a password and can view current values and device information without logging in. The user group **User** cannot change any settings.

- Only give the password for the user group **Installer** to qualified persons.

### **Log in as installer**

1. Open the user interface (see Section 10.1, page 49).
2. Click on [**Login**] in the top right.
3. Enter the password in the field **Password**. The standard password for the user group **Installer** is **pw1111**.
4. Click on [**Login**].

### **Log out as the installer.**

1. Open the user interface (see Section 10.1, page 49).
2. Click on the menu **User settings** in the top right.
3. Select [**Logout**] in the drop-down list.

## 10.3 Start Page Design of the User Interface

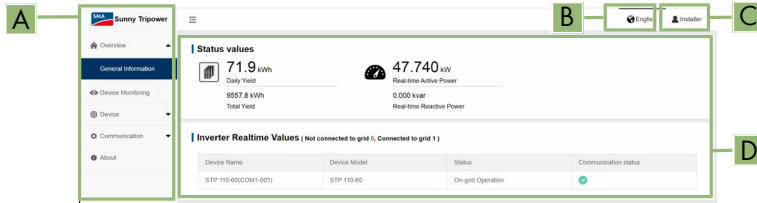

Figure 9: Design of the user interface's home page (example)

Position	Designation
A	<p><b>Menu</b></p> <ul style="list-style-type: none"> <li>• <b>Overview</b> <ul style="list-style-type: none"> <li>- <b>General information</b> Displays current measured values, the communication status and the device information</li> </ul> </li> <li>• <b>Device monitoring</b> Configuration of settings for the grid code and operating parameters</li> <li>• <b>Device</b> <ul style="list-style-type: none"> <li>- <b>Firmware update</b> Performing firmware updates for the inverter</li> <li>- <b>Inverter log</b> Export of a log of all inverter messages</li> <li>- <b>Fault recorder</b> Export of a log of all inverter fault messages</li> </ul> </li> <li>• <b>Communication</b> <ul style="list-style-type: none"> <li>- <b>Run information</b> Displays IP and MAC address of the device</li> <li>- <b>System maintenance</b> Logging the exports of messages or fault messages, performing a restart, resetting all settings</li> <li>- <b>System time</b> Setting the time and date of the system</li> <li>- <b>MODBUS</b> Switching the communication on and off via Modbus</li> <li>- <b>Port parameters</b> Configuration of Ethernet settings</li> </ul> </li> <li>• <b>About</b> Displays the inverter firmware version</li> </ul>

Position	Designation
B	<b>Language selection</b> <ul style="list-style-type: none"> <li>Setting the language of the user interface</li> </ul>
C	<b>User settings</b> <ul style="list-style-type: none"> <li>Change password</li> <li>Logout</li> </ul>
D	<b>Status display</b> <p>The various areas display information on the current status of the inverter.</p> <ul style="list-style-type: none"> <li> <b>Yield</b>            Displays the energy yield of the inverter         </li> <li> <b>Current power</b>            Displays the power currently being generated by the inverter.         </li> <li> <b>Communication status</b>            Displays whether the communication of the inverter with the Data Manager is trouble-free or whether there is an error message present.         </li> <li> <b>Device information</b>            Displays device name, device model and device status         </li> </ul>

## 10.4 Changing the Password

1. Open the user interface (see Section 10.1, page 49).
2. Log into the user interface as an **Installer** (see Section 10.2, page 50).
3. Select the menu **User settings**.
4. Select [**Change password**] in the drop-down list.
5. Change the password in the window that opens.
6. Select [**Save**] to save the changes.

## 10.5 Changing Operating Parameters

The operating parameters of the inverter are set to certain values by default. You can change the operating parameters to optimize the performance of the inverter.

This section describes the basic procedure for changing operating parameters. Always change operating parameters as described in this section.

### Requirements:

- Changes to grid-relevant parameters must be approved by the responsible grid operator.

### Procedure:

1. Open the user interface (see Section 10.1, page 49).
2. Log into the user interface as an **Installer** (see Section 10.2, page 50).
3. Click on [**Device monitoring**] in the menu.

4. Select [**Parameters**].
5. Select the desired parameter group.
6. Change the required parameters.
7. Select [**Save settings**] to save the changes.

## 10.6 Configuring the Country Data Set

### QUALIFIED PERSON

By default, the inverter is not set to a specific country data set. In order for the inverter to be able to feed in, a country data set must be set. The country data set must be adjusted to the installation site.

#### The country data set must be set correctly.

If you select a country data set which is not valid for your country and purpose, it can cause a disturbance in the PV system and lead to problems with the grid operator. When selecting the country data set, you must always observe the locally applicable standards and directives as well as the properties of the PV system (e.g. PV system size, grid-connection point).

- If you are not sure which standards and directives are valid for your country or purpose, contact the grid operator.

The basic procedure for changing operating parameters is explained in another section (see Section 10.5, page 52).

#### Procedure:

1. Open the user interface (see Section 10.1, page 49).
2. Log into the user interface as an **Installer** (see Section 10.2, page 50).
3. Click on [**Device monitoring**] in the menu.
4. Select [**Initialization**].
5. Select the desired country data set from the drop-down list **Grid code settings**.
6. Confirm change of the setting with [**Save settings**].

## 10.7 Configuring the Modbus Function

### QUALIFIED PERSON

The Modbus interface is activated by default and the communication port 502 set. The inverter supports Sunspec Modbus. For information on which Modbus registers are supported, see the technical information "Modbus® parameters and measured values" at [www.SMA-Solar.com](http://www.SMA-Solar.com).

Communication via Modbus is the condition for the operation of the inverter with the SMA Data Manager M. The Data Manager M enables monitoring and controlling of the inverter in Sunny Portal. For this, the inverter must be registered via Sunspec Modbus in the Data Manager M (see operating manual of the Data Manager M).

**i Measures for data security during activated Modbus interface**

If you activate the Modbus interface, there is a risk that unauthorized users may access and manipulate the data or devices in your PV system.

To ensure data security, take appropriate protective measures such as:

- Set up a firewall.
- Close unnecessary network ports.
- Only enable remote access via VPN tunnel.
- Do not set up port forwarding at the communication port in use.

**Procedure:**

1. Open the user interface (see Section 10.1, page 49).
2. Log into the user interface as an **Installer** (see Section 10.2, page 50).
3. Select [**Communication**] in the menu.
4. Select [**MODBUS**].
5. Switching the communication on and off via Modbus.

# 11 Disconnecting the Inverter from Voltage Sources

## ⚠ QUALIFIED PERSON

Prior to performing any work on the product, always disconnect it from all voltage sources as described in this section. Always adhere to the prescribed sequence.

## ⚠ WARNING

### Danger to life due to electric shock from destruction of the measuring device due to overvoltage

Overvoltage can damage a measuring device and result in voltage being present in the enclosure of the measuring device. Touching the live enclosure of the measuring device results in death or lethal injuries due to electric shock.

- Only use measuring devices with a DC input voltage range of 1100 V or higher.

### Procedure:

1. Disconnect the AC miniature circuit breaker and secure against reconnection.
2. Switch off all 4 DC load-break switches of the inverter and secure against reconnection.

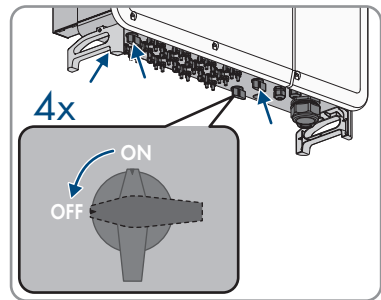

3. Wait until the LEDs have gone out.
4. Use a current clamp to ensure that no current is present in the DC cables.

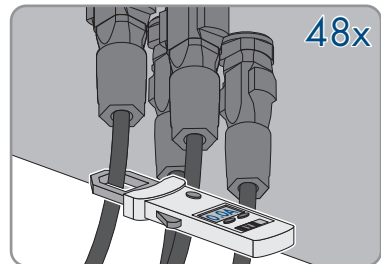

5. Note the position of the DC connector.

6.

**⚠ DANGER****Danger to life due to electric shock when touching exposed DC conductors or DC plug contacts if the DC connectors are damaged or loose**

The DC connectors can break or become damaged, become free of the DC cables, or no longer be connected correctly if the DC connectors are released and disconnected incorrectly. This can result in the DC conductors or DC plug contacts being exposed. Touching live DC conductors or DC plug connectors will result in death or serious injury due to electric shock.

- Wear insulated gloves and use insulated tools when working on the DC connectors.
- Ensure that the DC connectors are in perfect condition and that none of the DC conductors or DC plug contacts are exposed.
- Carefully release and remove the DC connectors as described in the following.

7. Release and remove the DC connectors. To do so, insert a flat-blade screwdriver or an angled screwdriver (blade width: 3.5 mm) into one of the side slots and pull the DC connectors out. When doing so, do not lever the DC connectors out, but insert the tool into one of the side slots only to release the locking mechanism, and do not pull on the cable.

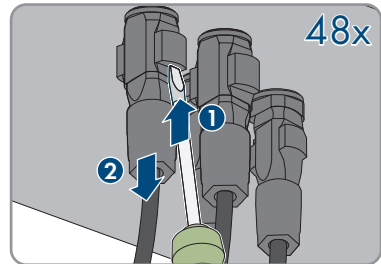

8. Ensure that the DC connectors on the product and those that are equipped with DC conductors are in perfect condition and that none of the DC conductors or DC plug contacts are exposed.

9.

**⚠ DANGER****Danger to life due to high voltages**

Once disconnected from voltage sources, residual voltages can remain in the product that should be allowed to discharge completely.

- Wait 5 minutes before opening the cable compartment.

10. Open the cable compartment (see Section 7, page 31).



11. Verify a de-energized state of the AC connection between L1 and L2, L2 and L3, L1 and L3 und L1 and grounding conductor, L2 and grounding conductor and L3 and grounding conductor using a suitable measuring device. For this purpose, hold the test probe to the conductors' ring terminal lugs.

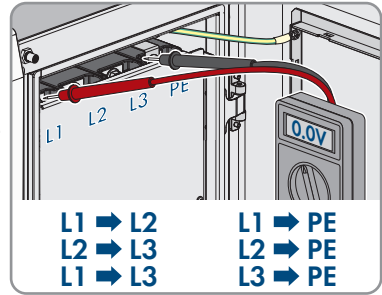

## 12 Event messages

### QUALIFIED PERSON

Event messages can be found under the parameter group **Extended RO**. The basic procedure for viewing and changing operating parameters is explained in another section (see Section 10.5, page 52).

Event number	Message, cause and corrective measures
002	<p><b>Grid overvoltage</b></p> <p>The grid voltage is higher than the set conservation value. In general, the inverter is reconnected to the supply grid when it is back in its normal mode.</p> <p><b>Corrective measures:</b></p> <ul style="list-style-type: none"> <li>• Wait until the grid voltage is within the normal range again. In general, the inverter is reconnected to the supply grid when the grid voltage is back within the normal range.</li> <li>• If the error occurs repeatedly, measure the present grid voltage and contact the local grid operator concerning solutions if the supply grid voltage is higher than the set value.</li> <li>• Ensure that the protection parameters are set correctly.</li> <li>• Ensure that the AC cable cross section meets the requirements.</li> <li>• If the fault cannot be rectified using the indicated corrective measures, contact Service.</li> </ul>
003	<p><b>Temporary grid overvoltage</b></p> <p>The transient grid voltage is higher than the standard value.</p> <p><b>Corrective measures:</b></p> <ul style="list-style-type: none"> <li>• Wait until the grid voltage is within the normal range again. In general, the inverter is reconnected to the supply grid when the grid voltage is back within the normal range.</li> <li>• If the fault cannot be rectified using the indicated corrective measures, contact Service.</li> </ul>

Event number	Message, cause and corrective measures
004	<p data-bbox="292 185 482 212"><b>Grid undervoltage</b></p> <p data-bbox="292 220 809 247">The grid voltage is lower than the set conservation value.</p> <p data-bbox="292 255 508 282"><b>Corrective measures:</b></p> <ul data-bbox="311 290 986 595" style="list-style-type: none"><li data-bbox="311 290 986 371">• Wait until the grid voltage is within the normal range again. In general, the inverter is reconnected to the supply grid when the grid voltage is back within the normal range.</li><li data-bbox="311 379 986 461">• If the error occurs repeatedly, measure the present grid voltage and contact the local grid operator concerning solutions if the supply grid voltage is lower than the set value.</li><li data-bbox="311 469 833 496">• Ensure that the protection parameters are set correctly.</li><li data-bbox="311 504 773 531">• Ensure that the AC cable is correctly connected.</li><li data-bbox="311 539 975 595">• If the fault cannot be rectified using the indicated corrective measures, contact Service.</li></ul>
005	<p data-bbox="292 611 418 638"><b>Low voltage</b></p> <p data-bbox="292 646 809 673">The grid voltage is lower than the set conservation value.</p> <p data-bbox="292 681 508 708"><b>Corrective measures:</b></p> <ul data-bbox="311 716 986 1021" style="list-style-type: none"><li data-bbox="311 716 986 798">• Wait until the grid voltage is within the normal range again. In general, the inverter is reconnected to the supply grid when the grid voltage is back within the normal range.</li><li data-bbox="311 805 986 887">• If the error occurs repeatedly, measure the present grid voltage and contact the local grid operator concerning solutions if the supply grid voltage is lower than the set value.</li><li data-bbox="311 895 833 922">• Ensure that the protection parameters are set correctly.</li><li data-bbox="311 930 773 957">• Ensure that the AC cable is correctly connected.</li><li data-bbox="311 965 975 1021">• If the fault cannot be rectified using the indicated corrective measures, contact Service.</li></ul>
007	<p data-bbox="292 1037 568 1064"><b>Temporary AC overcurrent</b></p> <p data-bbox="292 1072 953 1099">The AC output current exceeds the permissible upper limit of the inverter.</p> <p data-bbox="292 1107 508 1134"><b>Corrective measures:</b></p> <ul data-bbox="311 1142 975 1287" style="list-style-type: none"><li data-bbox="311 1142 975 1224">• Wait until the AC output current is within the normal range again. In general, the inverter is reconnected to the supply grid when the AC output current is back within the normal range.</li><li data-bbox="311 1232 975 1287">• If the fault cannot be rectified using the indicated corrective measures, contact Service.</li></ul>

Event number	Message, cause and corrective measures
008	<p><b>Grid overfrequency</b></p> <p>The grid frequency exceeds the permissible upper limit of the inverter.</p> <p><b>Corrective measures:</b></p> <ul style="list-style-type: none"> <li>• Wait until the grid frequency is within the normal range again. In general, the inverter is reconnected to the supply grid when the grid frequency is back within the normal range.</li> <li>• If the error occurs repeatedly, measure the present grid frequency and contact the local grid operator concerning solutions if the grid frequency is higher than the set value.</li> <li>• Ensure that the protection parameters are set correctly.</li> <li>• If the fault cannot be rectified using the indicated corrective measures, contact Service.</li> </ul>
009	<p><b>Grid underfrequency</b></p> <p>The grid frequency is below the permissible lower limit of the inverter.</p> <p><b>Corrective measures:</b></p> <ul style="list-style-type: none"> <li>• Wait until the grid frequency is within the normal range again. In general, the inverter is reconnected to the supply grid when the grid frequency is back within the normal range.</li> <li>• If the error occurs repeatedly, measure the present grid frequency and contact the local grid operator concerning solutions if the grid frequency is lower than the set value.</li> <li>• Ensure that the protection parameters are set correctly.</li> <li>• If the fault cannot be rectified using the indicated corrective measures, contact Service.</li> </ul>
010	<p><b>Grid power failure</b></p> <p>Alternating current switch or alternating current circuit is not connected.</p> <p><b>Corrective measures:</b></p> <ul style="list-style-type: none"> <li>• Wait until the alternating current switch or alternating current circuit reconnects again. The inverter is reconnected to the supply grid automatically.</li> <li>• Check whether the supply from the utility grid is normal.</li> <li>• Ensure that the AC cable is correctly connected.</li> <li>• Ensure that the conductors of the AC cables are connected to the correct terminals.</li> <li>• Ensure that AC circuit breaker is connected and switched on.</li> <li>• If the fault cannot be rectified using the indicated corrective measures, contact Service.</li> </ul>

Event number	Message, cause and corrective measures
011	<p data-bbox="292 185 415 209"><b>Device fault</b></p> <p data-bbox="292 220 617 244">There is a disturbance in the device.</p> <p data-bbox="292 255 508 279"><b>Corrective measures:</b></p> <ul data-bbox="311 290 981 440" style="list-style-type: none"> <li data-bbox="311 290 762 314">• Wait until the inverter is in normal mode again.</li> <li data-bbox="311 325 981 376">• Switch off the AC load-break switches and the DC load-break switches and switch them on again after 15 minutes to restart the inverter.</li> <li data-bbox="311 387 981 440">• If the fault cannot be rectified using the indicated corrective measures, contact Service.</li> </ul>
012	<p data-bbox="292 456 527 480"><b>Excessive stray current</b></p> <p data-bbox="292 491 972 515">This fault may be caused by weak solar irradiation or a moist environment.</p> <p data-bbox="292 526 508 550"><b>Corrective measures:</b></p> <ul data-bbox="311 561 997 711" style="list-style-type: none"> <li data-bbox="311 561 997 612">• Wait until the ambient conditions improve. The inverter is reconnected to the supply grid.</li> <li data-bbox="311 624 863 647">• Ensure that the AC and DC cables are insulated correctly.</li> <li data-bbox="311 659 975 711">• If the fault cannot be rectified using the indicated corrective measures, contact Service.</li> </ul>
013	<p data-bbox="292 727 465 751"><b>Supply grid fault</b></p> <p data-bbox="292 762 997 813">The grid voltage or grid frequency is outside the permissible range and the inverter cannot be connected properly to the supply grid.</p> <p data-bbox="292 825 508 849"><b>Corrective measures:</b></p> <ul data-bbox="311 860 997 1094" style="list-style-type: none"> <li data-bbox="311 860 981 943">• Wait until the value is within the normal range again. In general, the inverter is reconnected to the supply grid when the value is back within the normal range.</li> <li data-bbox="311 954 997 1037">• If the error occurs repeatedly, measure the present grid frequency and contact the local grid operator concerning solutions if the grid frequency is higher than the set value.</li> <li data-bbox="311 1048 975 1094">• If the fault cannot be rectified using the indicated corrective measures, contact Service.</li> </ul>
014	<p data-bbox="292 1110 572 1134"><b>10-minute grid overvoltage</b></p> <p data-bbox="292 1145 997 1197">The grid voltage exceeds the preset alternating voltage of the inverter over an extended period of time.</p> <p data-bbox="292 1208 508 1232"><b>Corrective measures:</b></p> <ul data-bbox="311 1243 981 1394" style="list-style-type: none"> <li data-bbox="311 1243 981 1326">• Wait until the value is within the normal range again. In general, the inverter is reconnected to the supply grid when the value is back within the normal range.</li> <li data-bbox="311 1337 975 1394">• If the fault cannot be rectified using the indicated corrective measures, contact Service.</li> </ul>

Event number	Message, cause and corrective measures
015	<p><b>Grid overvoltage</b></p> <p>The grid voltage is higher than the set conservation value.</p> <p><b>Corrective measures:</b></p> <ul style="list-style-type: none"> <li>• Wait until the grid voltage is within the normal range again.</li> <li>• If the error occurs repeatedly, measure the present grid voltage and contact the local grid operator concerning solutions if the supply grid voltage is higher than the set value.</li> <li>• Ensure that the protection parameters are set correctly.</li> <li>• Ensure that the cross section of the alternating current cable meets the requirements.</li> <li>• If the fault cannot be rectified using the indicated corrective measures, contact Service.</li> </ul>
016	<p><b>Output overload</b></p> <p>The configured PV array power is excessively high and is outside the normal operating range of the inverter.</p> <p>The inverter interrupts feed-in operation immediately after exceeding a threshold. When the fault is eliminated, the inverter automatically reconnects to the utility grid.</p> <p><b>Corrective measures:</b></p> <ul style="list-style-type: none"> <li>• Wait until the value is within the normal range again.</li> <li>• If the error occurs repeatedly, contact the Service.</li> </ul>
017	<p><b>Unbalanced load of grid voltage</b></p> <p>The inverter detects an unbalanced three-phase grid voltage</p> <p><b>Corrective measures:</b></p> <ul style="list-style-type: none"> <li>• Wait until the value is within the normal range again.</li> <li>• Measure the current grid voltage. If the grid conductor voltages vary considerably, contact the grid operator concerning proposals for solutions.</li> <li>• If the voltage difference between the 3 line conductors is within the permissible range of the local grid operator, change the parameter for the unbalanced load of the grid voltage.</li> <li>• If the fault cannot be rectified using the indicated corrective measures, contact Service.</li> </ul>

Event number	Message, cause and corrective measures
019	<b>Device fault</b>
020	<b>Corrective measures:</b>
021	<ul style="list-style-type: none"> <li>• Wait until the inverter is in normal mode again.</li> </ul>
022	<ul style="list-style-type: none"> <li>• Switch off the AC load-break switches and the DC load-break switches and switch them on again after 15 minutes to restart the inverter.</li> </ul>
024	
025	<ul style="list-style-type: none"> <li>• If the fault cannot be rectified using the indicated corrective measures, contact Service.</li> </ul>
030	
031	
032	
033	
034	
036	<p data-bbox="292 571 549 595"><b>Temperature disturbance</b></p> <p data-bbox="292 603 953 654">The temperature in the inverter is excessively high and is outside the safe range.</p> <ul style="list-style-type: none"> <li>• Check whether the inverter is exposed to direct sunlight. If so, provide sufficient shading.</li> <li>• Check and clean the air inlets.</li> <li>• Check whether the error message 070 (fan disturbance) is present. If so, replace the fan.</li> </ul>
037	<p data-bbox="292 836 524 860"><b>Communication failure</b></p> <p data-bbox="292 868 986 919">Error in the communication processor, the inverter continues feeding in, however. The cause must be determined by the Service.</p> <p data-bbox="292 935 508 959"><b>Corrective measures:</b></p> <ul style="list-style-type: none"> <li>• If this message is displayed frequently, contact the Service.</li> </ul>
038	<p data-bbox="292 1008 415 1032"><b>Device fault</b></p> <p data-bbox="292 1040 508 1064"><b>Corrective measures:</b></p> <ul style="list-style-type: none"> <li>• Wait until the inverter is in normal mode again.</li> <li>• Switch off the AC load-break switches and the DC load-break switches and switch them on again after 15 minutes to restart the inverter.</li> <li>• If the fault cannot be rectified using the indicated corrective measures, contact Service.</li> </ul>

Event number	Message, cause and corrective measures
039	<p><b>Low system insulation resistance</b></p> <p>Generally, the fault is caused by poor insulation of the module/cable to ground or by rainfall and a moist environment.</p> <p><b>Corrective measures:</b></p> <ul style="list-style-type: none"> <li>• Check whether the ISO insulation conservation value is excessively high and ensure it complies with the local requirements.</li> <li>• Check the resistance of the DC string or DC cable to ground. Rectify the fault if a short circuit or a damaged insulating layer is present.</li> <li>• If the cable shows no abnormalities and the fault occurs on rainy days, check again when the weather is good.</li> <li>• If the fault cannot be rectified using the indicated corrective measures, contact Service.</li> </ul>
040	<p><b>Device fault</b></p>
041	<p><b>Corrective measures:</b></p>
042	<ul style="list-style-type: none"> <li>• Wait until the inverter is in normal mode again.</li> <li>• Switch off the AC load-break switches and the DC load-break switches and switch them on again after 15 minutes to restart the inverter.</li> <li>• If the fault cannot be rectified using the indicated corrective measures, contact Service.</li> </ul>
043	<p><b>Low ambient temperature</b></p> <p>The ambient temperature is lower than the operating temperature intended for the inverter during normal operation.</p> <p><b>Corrective measures:</b></p> <ul style="list-style-type: none"> <li>• Stop and disconnect the inverter. Restart the inverter when the ambient temperature is within the permissible operating range again.</li> </ul>
044	<p><b>Device fault</b></p>
045	<p><b>Corrective measures:</b></p>
046	<ul style="list-style-type: none"> <li>• Wait until the inverter is in normal mode again.</li> <li>• Switch off the AC load-break switches and the DC load-break switches and switch them on again after 15 minutes to restart the inverter.</li> <li>• If the fault cannot be rectified using the indicated corrective measures, contact Service.</li> </ul>
047	<p><b>PV input configuration abnormal, PV input mode error</b></p> <p><b>Corrective measures:</b></p> <ul style="list-style-type: none"> <li>• Disconnect the inverter. Resetting the input mode of the PV system.</li> </ul>



Event number	Message, cause and corrective measures
048	<b>Device fault</b>
049	<b>Corrective measures:</b>
050	<ul style="list-style-type: none"> <li>• Wait until the inverter is in normal mode again.</li> </ul>
053	<ul style="list-style-type: none"> <li>• Switch off the AC load-break switches and the DC load-break switches and switch them on again after 15 minutes to restart the inverter.</li> </ul>
052	
054	<ul style="list-style-type: none"> <li>• If the fault cannot be rectified using the indicated corrective measures, contact Service.</li> </ul>
055	
056	
059	
060	
070	<b>Fan alarm</b>
	<b>Corrective measures:</b>
	<ul style="list-style-type: none"> <li>• Check whether the fans work properly and whether they are blocked by foreign objects. If they are blocked, remove foreign objects.</li> <li>• If a fan is not working properly, disconnect the inverter from voltage sources and replace the fan.</li> </ul>
071	<b>Alternating current side surge arrester alarm</b>
	<b>Corrective measures:</b>
	<ul style="list-style-type: none"> <li>• Check the surge arrester and replace, if necessary.</li> </ul>
072	<b>Direct current side surge arrester alarm</b>
	<b>Corrective measures:</b>
	<ul style="list-style-type: none"> <li>• Check the surge arrester and replace, if necessary.</li> </ul>
076	<b>Device fault</b>
	<b>Corrective measures:</b>
	<ul style="list-style-type: none"> <li>• Wait until the inverter is in normal mode again.</li> <li>• Switch off the AC load-break switches and the DC load-break switches and switch them on again after 15 minutes to restart the inverter.</li> <li>• If the fault cannot be rectified using the indicated corrective measures, contact Service.</li> </ul>
078	<b>PV[#] abnormal</b>
079	<b>Corrective measures:</b>
080	<ul style="list-style-type: none"> <li>• Check if the -nth PV string must be connected. If not, ignore the event. If so, check the connection state and ensure that there is a reliable connection.</li> </ul>
081	<ul style="list-style-type: none"> <li>• If the fault cannot be rectified using the indicated corrective measures, contact Service.</li> </ul>

Event number	Message, cause and corrective measures
105	<p><b>Error during self-test for protective status on the grid side</b></p> <p><b>Corrective measures:</b></p> <ul style="list-style-type: none"> <li>Restart the processor or rectify the error via the user interface.</li> <li>If the fault cannot be rectified using the indicated corrective measures, contact Service.</li> </ul>
106	<p><b>Grounding cable defective</b></p> <p><b>Corrective measures:</b></p> <ul style="list-style-type: none"> <li>Ensure that the AC cable is correctly connected.</li> <li>Ensure that the insulation between the grounding cable and the AC cable is correct.</li> <li>If the fault cannot be rectified using the indicated corrective measures, contact Service.</li> </ul>
116 117	<p><b>Device fault</b></p> <p><b>Corrective measures:</b></p> <ul style="list-style-type: none"> <li>Wait until the inverter is in normal mode again.</li> <li>Switch off the AC load-break switches and the DC load-break switches and switch them on again after 15 minutes to restart the inverter.</li> <li>If the fault cannot be rectified using the indicated corrective measures, contact Service.</li> </ul>
220 221 222 223 224 225 226 227	<p><b>PV[#] abnormal</b></p> <p><b>Corrective measures:</b></p> <ul style="list-style-type: none"> <li>Check if the -nth PV string must be connected. If not, ignore the event. If so, check the connection state and ensure that there is a reliable connection.</li> <li>Ensure that the -nth DC fuse is not damaged.</li> <li>If the fault cannot be rectified using the indicated corrective measures, contact Service.</li> </ul>

Event number	Message, cause and corrective measures
448	<b>String [#] reverse polarity</b>
449	<b>Corrective measures:</b>
450	<ul style="list-style-type: none"><li>• Check whether there is reverse polarity on the corresponding PV string. If</li></ul>
451	<ul style="list-style-type: none"><li>so, open the DC switch and adjust the polarity if the solar irradiation is</li></ul>
452	<ul style="list-style-type: none"><li>low and the string electrical current is below 0.5 A.</li></ul>
453	<ul style="list-style-type: none"><li>• If the fault cannot be rectified using the indicated corrective measures,</li></ul>
454	<ul style="list-style-type: none"><li>contact Service.</li></ul>
455	
456	
457	
458	
459	
460	
461	
462	
463	
464	
465	
466	
467	
468	
469	
470	
471	

---

Event number	Message, cause and corrective measures
532	<b>String [#] reverse polarity alarm</b>
533	<b>Corrective measures:</b>
534	<ul style="list-style-type: none"> <li>• Check whether there is reverse polarity on the corresponding PV string. If so, open the DC switch and adjust the polarity if the solar irradiation is low and the string electrical current is below 0.5 A.</li> </ul>
535	
536	
537	<ul style="list-style-type: none"> <li>• If the fault cannot be rectified using the indicated corrective measures, contact Service.</li> </ul>
538	
539	
540	
541	
542	
543	
544	
545	
546	
547	
548	<b>String [#] disturbance of the output current</b>
549	<b>Corrective measures:</b>
550	<ul style="list-style-type: none"> <li>• Check whether the relevant PV module is protected. If so, remove the protective device and ensure the PV module is clean.</li> </ul>
551	
552	<ul style="list-style-type: none"> <li>• Ensure that the PV module shows no signs of abnormal aging.</li> </ul>
553	<ul style="list-style-type: none"> <li>• If the fault cannot be rectified using the indicated corrective measures, contact Service.</li> </ul>
554	
555	
556	
557	
558	
559	
560	
561	
562	
563	

Event number	Message, cause and corrective measures
564	<b>String [#] reverse polarity alarm</b>
565	<b>Corrective measures:</b>
566	<ul style="list-style-type: none"> <li>• Check whether there is reverse polarity on the corresponding PV string. If so, open the DC switch and adjust the polarity if the solar irradiation is low and the string electrical current is below 0.5 A.</li> </ul>
567	
568	
569	<ul style="list-style-type: none"> <li>• If the fault cannot be rectified using the indicated corrective measures, contact Service.</li> </ul>
570	
571	
580	<b>String [#] disturbance of the output current</b>
581	<b>Corrective measures:</b>
582	<ul style="list-style-type: none"> <li>• Check whether the relevant PV module is protected. If so, remove the protective device and ensure the PV module is clean.</li> </ul>
583	
584	<ul style="list-style-type: none"> <li>• Ensure that the PV module shows no signs of abnormal aging.</li> </ul>
585	<ul style="list-style-type: none"> <li>• If the fault cannot be rectified using the indicated corrective measures, contact Service.</li> </ul>
586	
587	

## 13 Decommissioning the Inverter

### **⚠ QUALIFIED PERSON**

To decommission the inverter completely upon completion of its service life, proceed as described in this Section.

#### Requirements:

- Original packaging or packaging suitable for the weight and dimensions of the product must be available.
- A pallet must be available.
- Mounting material for attaching the packaging on the pallet must be available (e.g. tie-down straps).
- All transport handles must be in place.

#### Procedure:

1.

### **⚠ DANGER**

#### **Danger to life due to high voltages**

- Disconnect the inverter from all voltage sources (see Section 11, page 55).

2.

### **⚠ CAUTION**

#### **Risk of burns due to hot enclosure parts**

- Wait 30 minutes for the enclosure to cool down.

3. Open the cable compartment (see Section 7, page 31).
4. Remove the conductors for AC connection by loosening the hex nuts (AF19) and then removing the ring terminal nuts with the conductors from the threads.
5. Loosen the swivel nut on the cable gland for the AC connection on the bottom of the inverter.

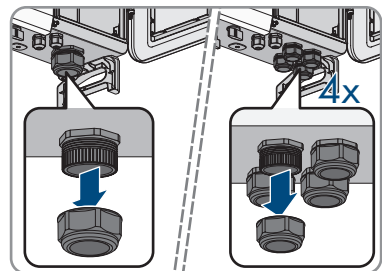

6. Feed the cable out of the device through the cable gland for the AC connection.
7. Route the cable through the swivel nut.
8. Tighten the swivel nut on the cable gland for the AC connection.
9. Attach the protective cover in front of the AC connection using the 4 screws (PH2, torque: 1.5 Nm).
10. Remove the grounding by loosening the screw at the connection points for the additional grounding (PH3).

11. Remove the RJ45 plug of the cable from the network jack of the communication assembly.
12. Remove the swivel nut from the cable gland for the communication cable.

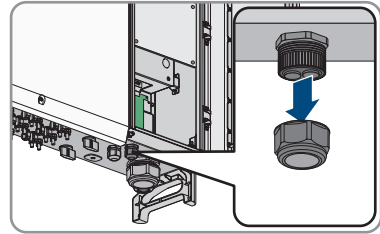

13. Feed the network cable out of the device through the cable gland for communication cables.
14. Feed the network cable through the swivel nut. For this, remove the two-hole cable support sleeve.
15. Tighten the swivel nut on the cable gland hand-tight.
16. Move the limiting lever back to its original position and close the cable compartment cover.
17. Tighten the 2 screws on the cable compartment cover (TX30, torque: 4.3 Nm).

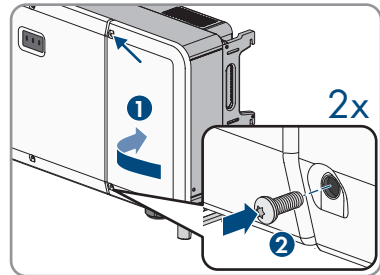

18. Remove the screws to attach the inverter to the mounting bracket (PH3).
19. Remove the sealing screws on the attachment bars of the inverter using a flat-blade screwdriver (4 mm).
20. If the inverter is to be lifted out of the mounting bracket using a hoist, screw the eye bolts into the 2 upper tapped holes on the right-hand and left-hand side of the inverter and attach the hoist to them. The hoist must be suitable to take the weight of the inverter.

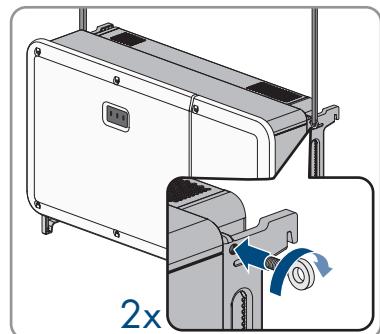

21. If the inverter is to be lifted out of the mounting bracket without using a hoist, screw the transport handles as far as they will go into the tapped holes on the right-hand and left-hand side until they lie flush with the enclosure. When doing so, ensure that the transport handles are screwed into the tapped holes so that they are perfectly straight. If the transport handles are not screwed in straight, this can make it more difficult or even impossible to unscrew them later on and can damage the tapped holes to the extent that transport handles can no longer be screwed into them.

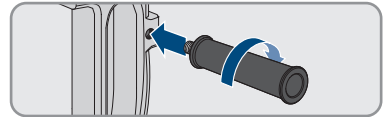

22. Remove the inverter from the bracket and place it in the transport packaging or on a suitable surface.
23. Remove all 4 transport handles from the tapped holes or remove the eye bolts of the hoist and again screw in the sealing screws (flat-blade screwdriver 4 mm, 2 Nm).
24. Remove the mounting bracket from the wall or profile rails.
25. Remove the mounting bracket by disconnecting the bracket parts from the connecting rod (PH2).
26. If the inverter is to be stored or shipped, pack the inverter and the parts of the mounting bracket. Use the original packaging or packaging that is suitable for the weight and dimensions of the inverter and secure with tie-down straps on the Euro pallet.
27. Dispose of the inverter in accordance with the locally applicable disposal regulations for electronic waste.



## 14 Procedure for Receiving a Replacement Device

### QUALIFIED PERSON

Under fault conditions, the product may need to be replaced. If this is the case, you will receive a replacement device from SMA Solar Technology AG. If you received a replacement device, replace the defective product with the replacement device as described below.

#### **Procedure:**

1. Decommission the defective product (see Section 13, page 70).
2. Mount the replacement device (see Section 6, page 23) and make the electrical connections (see Section 8, page 32).
3. Commission the replacement device (see Section 9.2, page 47).
4. Establish a connection to the user interface of the inverter (see Section 10.1, page 49).
5. Configure the country data set (see Section 10.6, page 53).
6. If the defective product had been registered by a communication product, replace it with the new product in the communication product (see operating manual of communication product).
7. Pack the defective product in the packaging of the replacement device and arrange with SMA Solar Technology AG for it to be picked up.

## 15 Maintenance

### 15.1 Safety during Maintenance

#### QUALIFIED PERSON

#### DANGER

##### **Danger to life due to electric shock when live components or cables are touched**

High voltages are present in the conductive components or cables of the product. Touching live parts and cables results in death or lethal injuries due to electric shock.

- Do not touch non-insulated parts or cables.
- Disconnect the product from voltage sources and ensure it cannot be reconnected before working on the device.
- Wear suitable personal protective equipment for all work on the product.

#### NOTICE

##### **Damage to the inverter due to unapproved spare parts**

If accessories and spare parts not approved by SMA Solar Technology AG are used for maintenance, the product may be damaged.

- Only use spare parts approved by SMA Solar Technology AG.

### 15.2 Maintenance routines

#### QUALIFIED PERSON

Task	Description	Time period
Cleaning the product	Check the temperature of the inverter and for dust contamination. Clean the enclosure if necessary (see Section 15.3, page 75).	Every 6 to 12 months, depending on the environment's dust content
Cleaning the air inlet and air outlet	Check the condition of the air inlet and air outlet and check for dirt and blockages. If necessary, remove dirt and blockages so that the ventilation of the device is ensured again.	Every 6 to 12 months, depending on the environment's dust content
Check the fans	Check if there is a fan warning message or if there are unusual noises when the fan is rotating. If necessary, perform fan maintenance (see Section 15.4, page 75).	Every 12 months

Task	Description	Time period
Check the cable inputs	Check whether all cable glands are sufficiently sealed. Seal the cable glands again if necessary.	Every 12 months
Check the electrical connections	Check that all cables are properly connected and all cables are undamaged. If necessary, replace the cable or connect it correctly.	Every 6 to 12 months

### 15.3 Clean the product

**NOTICE**

**Damage to the product due to cleaning agents**

The use of cleaning agents may cause damage to the product and its components.

- Clean the product and all its components only with a cloth moistened with clear water.

**Procedure:**

- Ensure that the product is free of dust, foliage and other dirt.

### 15.4 Maintaining the Fan

**⚠ QUALIFIED PERSON**

#### 15.4.1 Removing the Fan Assembly

1. Loosen the screw on the sealing plate of the fan (PH2) and remove the sealing plate. Store the screw safely.
2. To release the plug connections of the fans, press on the bulge of the lock hook and pull the plug out of the jack of the plug connection.

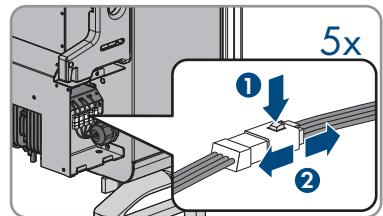
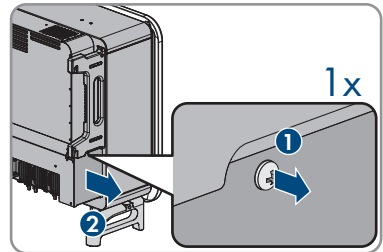

3. Loosen the screw on the fan holder (PH2).

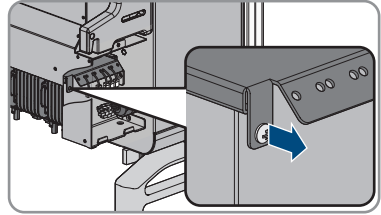

4. Pull out the fan holder.

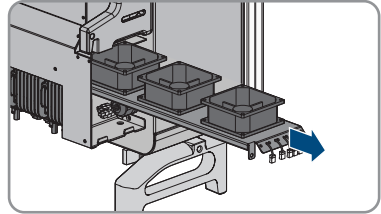

5. Clean the fan assembly with a soft brush or a vacuum cleaner. If the fan assembly is defective, replace it.
6. Reinstall the new or cleaned fan assembly into the inverter (see Section 15.4.2, page 76).

## 15.4.2 Installing the Fan Assembly

1. Insert the fan assembly into the inverter.
2. Tighten the provided M4 screw on the fan holder (PH2, torque: 1.5 Nm).
3. Restore the plug connections of the fans in the original order by pushing the plug into the jack of the plug connection while pressing on the bulge of the lock hook at the same time.

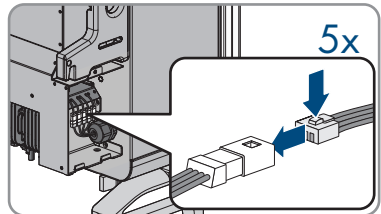

- ☑ The plug snaps into place.

4. Insert the sealing plate of the fan and fix it with the screw (PH2, torque: 1.5 Nm).
5. Recommission the inverter (see Section 9.2, page 47).

## 16 Technical Data

### DC Input

Maximum PV array power	165000 W <sub>p</sub> STC
Maximum input voltage	1100 V
MPP Voltage Range	200 V to 1000 V
MPP Voltage Range for rated power	500 V to 800 V
Rated input voltage	585 V
Minimum input voltage	200 V
Initial input voltage	250 V
Maximum input current per input with an input voltage < 600 V	22 A
Maximum input current per input with an input voltage > 600 V	26 A
Maximum short-circuit current per input <sup>1)</sup>	40 A
Maximum reverse current into the PV array <sup>2)</sup>	0 A
Number of independent MPP inputs	12
Strings per MPP input	2
Surge category in accordance with IEC 62109-1	II

### AC output

Rated power at nominal AC voltage, 50 Hz	110000 W
Maximum apparent power at $\cos \varphi = 1$	110000 VA
Rated apparent power at $\cos \varphi = 1$	110000 VA
Nominal grid voltage	400 V
Rated grid voltage	400 V
Voltage range <sup>3)</sup>	320 V to 460 V
Rated current at nominal grid voltage	158.8 A
Maximum output current	158.8 A
Maximum residual output current	420 A

<sup>1)</sup> In accordance with IEC 62109-2:  $I_{SC,PV}$

<sup>2)</sup> The topology prevents a reverse current from the inverter in the system

<sup>3)</sup> Depending on the configured country data set

Duration of the maximum residual output current	1 ms
Total harmonic distortion	< 3 %
Inrush current	< 10% of the nominal AC current for a maximum of 10 ms
Rated grid frequency	50 Hz
Grid frequency <sup>3)</sup>	50 Hz / 60 Hz
Operating range at grid frequency 50 Hz	45 Hz to 55 Hz
Operating range at grid frequency 60 Hz	55 Hz to 65 Hz
Power factor at rated power	1
Displacement power factor, adjustable	0.8 overexcited to 0.8 underexcited
Feed-in phases	3
Connection phases	3 grounding conductor
Surge category in accordance with IEC 62109-1	III

### Efficiency

Maximum efficiency, $\eta_{\max}$	98.6 %
European weighted efficiency, $\eta_{\text{EU}}$	98.4 %

### Protective devices

DC reverse polarity protection	Available
Input-side disconnection point	DC load-break switch
AC overvoltage protection"	Surge arrester type 2
DC overvoltage protection	Surge arrester type 2
AC short-circuit current capability	Current control
Grid monitoring	Available
Maximal output overcurrent protection	386 A
Ground fault monitoring	Insulation monitoring: $R_{\text{iso}} > 36 \text{ k}\Omega$
All-pole sensitive residual-current monitoring unit	Available
Active anti-islanding method	Frequency shift

### General data

Width x height x depth	1117 mm x 682 mm x 363 mm
Weight with enclosure lid and connecting plate	93.5 kg

Length x width x height of the packaging	1220 mm x 840 mm x 618 mm
Transport weight	125 kg
Climatic category in accordance with IEC 60721-3-4	4K4H
Environmental category	Outdoors
Pollution degree of all enclosure parts	2
Operating temperature range	-30 °C to +60 °C
Maximum permissible value for relative humidity, condensing	100 %
Maximum operating altitude above mean sea level (MSL)	3000 m
Typical noise emission	78 dB(A)
Power loss in night mode	< 5 W
Power control / Demand response (DRED)	Communication via Modbus interface
Export limiting in accordance with AS/NZS 4777.2	EDMM-10, EMETER-20
Demand response mode in accordance with AS/NZS 4777.2	DRM0
Topology	Transformerless (Non-isolated)
Cooling method	Active cooling
Number of fans	5
Degree of protection for electronics in accordance with IEC 60529	IP66
Protection class in accordance with IEC 62109-1	I

## Climatic Conditions

### Installation in accordance with IEC 60721-3-4, Class 4K26

Extended temperature range	-30 °C to +60 °C
Extended humidity range	0% to 100%
Threshold for relative humidity, non-condensing	100 %
Extended air pressure range	79.5 kPa to 106 kPa

### Transport in accordance with IEC 60721-3-2, Class 2K12

Temperature range	-40 °C to +70 °C
-------------------	------------------

## Equipment

DC terminal	SUNCLIX DC connector
AC connection	Cable lugs (up to 240 mm <sup>2</sup> )

## Torques

Connecting rod screws for mounting bracket (M4x10, PH2)	1.5 Nm
Screws to mount the mounting bracket to profile rails (M10x45, WAF 16)	35 Nm
Screws to attach the inverter to the mounting bracket (M5x65, PH3)	4.5 Nm
Screw to attach the additional grounding (M6x12, PH3)	6 Nm to 7 Nm
Screw connections, AC connection terminals (WAF 19)	20 Nm to 30 Nm
Protective cover screws AC connection (PH2)	1.5 Nm
Enclosure lid screws (TX30)	4.3 Nm



## 17 Contact

You can find your country's contact information at:



<https://go.sma.de/service>

## 18 EU Declaration of Conformity

within the scope of the EU directives

- Electromagnetic compatibility 2014/30/EU (29.3.2014 L 96/79-106) (EMC)
- Low Voltage Directive 2014/35/EU (29.3.2014 L 96/357-374) (LVD)
- Restriction of the use of certain hazardous substances 2011/65/EU (L 174/88, June 8, 2011) and 2015/863/EU (L 137/10, March 31, 2015) (RoHS)



SMA Solar Technology AG confirms herewith that the products described in this document are in compliance with the fundamental requirements and other relevant provisions of the above-mentioned directives. The entire EU Declaration of Conformity can be found at [www.SMA-Solar.com](http://www.SMA-Solar.com).

## 19 UK Declaration of Conformity

according to the regulations of England, Wales and Scotland

- Electromagnetic Compatibility Regulations 2016 (SI 2016/1091)
- Electrical Equipment (Safety) Regulations 2016 (SI 2016/1101)
- Radio Equipment Regulations 2017 (SI 2017/1206)
- The Restriction of the Use of Certain Hazardous Substances in Electrical and Electronic Equipment Regulations 2012



SMA Solar Technology AG confirms herewith that the products described in this document are in compliance with the fundamental requirements and other relevant provisions of the above-mentioned regulations. The entire UK Declaration of Conformity can be found at [www.SMA-Solar.com](http://www.SMA-Solar.com).



[www.SMA-Solar.com](http://www.SMA-Solar.com)

